



GUIDANCE NOETS
GD26-2020

CHINA CLASSIFICATION SOCIETY

**GUIDELINES FOR COMPLIANCE SURVEY OF
CONSTRUCTION AND EQUIPMENT OF SHIPS
TRANSITING CANALS
2020**

Effective from 01 November 2020

CONTENTS

CHAPTER 1	GENERAL	1
1.1	Purpose	1
1.2	Scope of application	1
1.3	Plans and documents	1
1.4	Survey scope	2
1.5	Issuance of declaration of survey for compliance	2
1.6	Responsibility of each party	4
1.7	Basis for development of the Guidelines	5
Appendix 1 Construction and Equipment Requirements for Ships Transiting the Panama Canal		6
Definitions		6
1	Requirements for navigation bridge	6
2	Construction, number and location of chocks and bitts	13
3	Requirement for pilot platforms and shelters on certain vessels	19
4	Pilot transfer arrangements	21
5	Miscellaneous	26
Annex Declaration of Survey Regarding Compliance with Requirements for Ship Construction and Equipment of the Panama Canal		27
Appendix 2 Construction and Equipment Requirements for Ships Transiting the Suez Canal		36
1	Accommodations	36
2	Mooring and anchoring	36
3	Fire fighting equipment	37
4	Means of embarkation on and disembarkation from ships for pilots	38
5	Signal equipment	38
6	Draught Marks	43
7	Additional requirements for container ships	43
8	Electrical installations	43
Annex Declaration of Survey Regarding Compliance with Requirements for Ship Construction and Equipment of the Suez Canal		45

CHAPTER 1 GENERAL

1.1 Purpose

1.1.1 The purpose of the Guidelines is to provide guidance to the survey service for compliance with the Panama or Suez Canal Rules of Navigation (hereinafter referred to as “the Rules”) carried out by China Classification Society (hereinafter referred to as “CCS”).

1.2 Scope of application

1.2.1 The Guidelines are applicable to ships classed with CCS and transiting the Panama or Suez Canal.

1.2.2 In addition to satisfying the requirements of SOLAS, ships transiting canals are also to consider the requirements^① of the Rules (refer to Appendix 1 and 2 of the Guidelines).

1.2.3 Only provisions related to ship “construction” and “equipment provision” of the Rules are contained in the Guidelines. For a specific ship transiting canals, attention is also to be given to other relevant provisions of the Canal Authority and the Administration of the flag State.

1.3 Plans and documents

1.3.1 For ships applying for issuance of the Declaration of Survey Regarding Compliance with Requirements for Ship Construction and Equipment of the Panama Canal, the following plans and documents are to be submitted for examination^②:

- (1) arrangement plan of towing and mooring;
- (2) arrangement plan of pilot platforms and shelters;
- (3) arrangement plan of mast and signal;
- (4) arrangement of the navigation bridge, including but not limited to:
 - arrangement of VHF radio;
 - AIS pilot plug;
 - arrangement of rudder angle indicators;

① For details of the requirements, refer to Maritime Regulations for the Operation of the Panama Canal and Notices to Mariners released on the official website of the Panama Canal Authority at <https://www.panacanal.com/eng/op/notices/index.html> and the Suez Canal Rules of Navigation released on the official website of the Suez Canal Authority at <http://www.suezcanal.gov.eg/English/Navigation/Pages/RulesOfNavigation.aspx>.

② Where the existing drawings of ships in service do not satisfy the requirements of the Canal Authority, they are to be revised correspondingly to satisfy such requirements and only the revised part needs to be submitted.

- propeller revolution tachometer indicators;
- electrical equipment at deck wings specified in the Guidelines.

(5) pilot ladder and transfer arrangements (the arrangement of accommodation ladder is also to be submitted if they are used in conjunction with the accommodation ladder);

(6) plans and documents demonstrating the maximum height above waterline is 57.91 m.

1.3.2 For ships applying for issuance of the Declaration of Survey Regarding Compliance with Requirements for Ship Construction and Equipment of the Suez Canal, the following plans and documents are to be submitted for examination ^③:

- (1) general arrangement plan/arrangement plan of equipment in compartment;
- (2) arrangement plan of anchoring and mooring;
- (3) arrangement plan of mast and signal.

1.4 Survey scope

For the purpose of the Guidelines, the survey scope with regard to the application for issuance of the Declaration of Survey Regarding Compliance with Requirements for Ship Construction and Equipment of the relevant Canal is given in Annex 1 and 2 of the Guidelines.

1.5 Issuance of declaration of survey for compliance^④

1.5.1 The plan approval and survey for compliance with requirements for ship construction and equipment as contained in relevant canal rules of navigation is carried out by CCS upon voluntary application by the shipyard or shipowner after the plans and documents required in 1.3 are approved by relevant Canal Authority. The Declaration of Survey Regarding Compliance with Requirements for Ship Construction and Equipment of the relevant Canal is issued where the above plan approval and survey are satisfactory.

1.5.2 The Declaration of Survey Regarding Compliance with Requirements for Ship Construction and Equipment of the relevant Canal is issued provided that plans and documents listed in 1.3.1 or 1.3.2 have been approved by CCS.

1.5.3 The Declaration of Survey Regarding Compliance with Requirements for Ship Construction and Equipment of the relevant Canal need not be issued for ships not transiting relevant canal for the first time, unless any modification has been made regarding requirements for ship construction and equipment in relevant Canal Rules of Navigation or such requirements have

③ Where the existing drawings of ships in service do not satisfy the requirements of the Canal Authority, they are to be revised correspondingly to satisfy such requirements and only the revised part needs to be submitted. For ships applying for the issuance of Declaration of Survey Regarding Compliance with Requirements for Ship Construction and Equipment of the Suez Canal, the examination of relevant plans and documents may be carried out by the site surveyor taking into account the relatively simple requirements for ships given in the Suez Canal Rules of Navigation.

④ See Figure 1 Flowchart of Issuance of Declaration of Survey Regarding Compliance with Requirements for Ship Construction and Equipment of the relevant Canal.

been updated and they are retrospective.

1.5.4 The Declaration of Survey Regarding Compliance with Requirements for Ship Construction and Equipment of the relevant Canal issued to a ship has a long time period of validity, unless any modification has been made which does not comply with requirements for ship arrangement and equipment in relevant Canal Rules of Navigation or such requirements have been updated and they are retrospective.

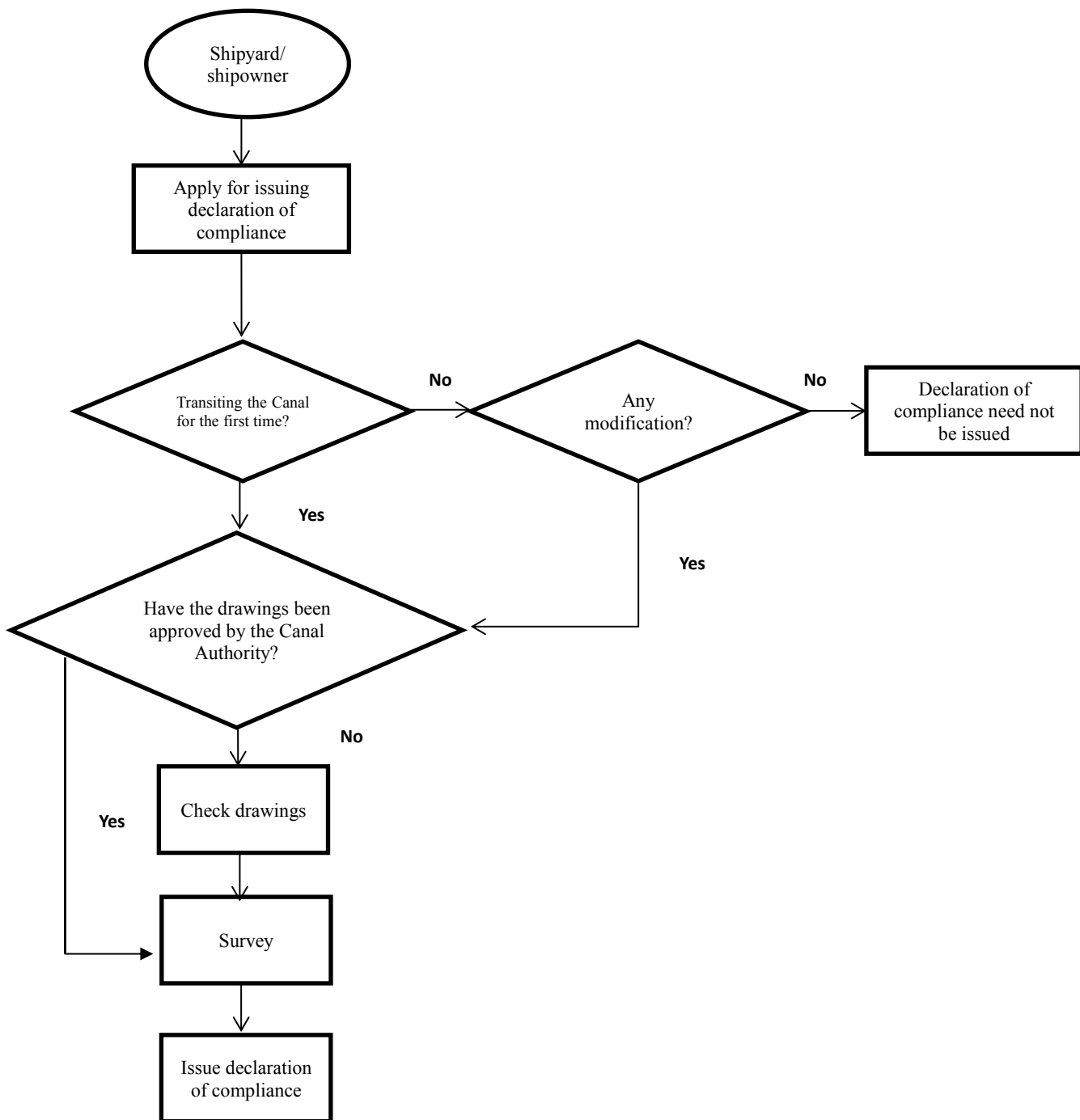

Figure 1 Flowchart of Issuance of the Declaration of Survey Regarding Compliance with Requirements for Ship Construction and Equipment of the relevant Canal

1.6 Responsibility of each party

The declaration of survey for compliance is not issued on behalf of the relevant Canal Authority,

but indicates compliance with CCS understanding (see Appendix 1 and 2 of the Guidelines) of requirements for construction and equipment provision for ships transiting the Canal given in the Rules of Navigation. It does not preclude the possibility that the relevant Canal Authority might require additional evidence/inspection when the ship is transiting the Canal.

1.7 Basis for development of the Guidelines

1.7.1 The Guidelines are developed based on the following documents:

- (1) Maritime Regulations for the Operation of the Panama Canal and Notices to Mariners (<https://www.pancanal.com/eng/op/notices>);
- (2) Notice on Issuing the Declaration of Survey for Compliance with Ship Requirements of the Rules of Navigation of the Panama Canal Authority — CCS (2017) technical notice no. 15/ total no. 263;
- (3) Rules of Navigation of the Suez Canal Authority (<http://www.suezcanal.gov.eg/English/Navigation/Pages/RulesOfNavigation.aspx>);
- (4) Notice on Issuing the Declaration of Survey for Compliance with Equipment Requirements of the Rules of Navigation of the Suez Canal Authority — CCS (2015) circular no. 15/ total no. 176.

Appendix 1 Construction and Equipment Requirements for Ships Transiting the Panama Canal

Definitions

- a. *Length overall (LOA)*: The distance between the forward and after extremities of a vessel, including the bulbous bow and protrusions (also maximum length).
- b. *Maximum beam*: The maximum breadth (width) of the hull between the outside surfaces of the shell plating.
- c. *Maximum width*: The extreme width of a vessel, including protrusions, at its widest point.
- d. *Panamax vessels (PANAMAX)*: Vessels that comply with the size and draft limitations of the Panamax locks; namely, 294.13 meters (965 feet) in length by 32.31 meters (106 feet) in beam by 12.04 meters (39.50 feet), TFW draft.
- e. *Panamax Plus vessels (PANAMAX PLUS)*: All Panamax vessels authorized for TFW drafts greater than 12.04 meters (39.50 feet) up to 15.2 meters (49.87 feet) and approved for transit of the new locks.
- f. *Neopanamax vessels (Neo PANAMAX)*: All vessels with dimensions greater than Panamax that comply with the size and draft limitations of the new locks; namely, 366 meters (1200.48 feet) in length by 49 meters (160.72 feet) in beam by 15.2 meters (49.87 feet), TFW draft.
- g. *Protrusion*: Anything that extends beyond any portion of the hull of a vessel, whether it is permanent or temporary, except for the main anchors.
- h. *Safe Working Load (SWL)*: The SWL should not exceed 80 percent of the design load.

1 Requirements for navigation bridge

1.1 Wheelhouse

- 1.1.1 Wheelhouse windows shall be of sufficient size and number to provide a clear view.
- 1.1.2 Wheelhouse windows shall be of clear safety glass.
- 1.1.3 Tinted windows must be removable.
- 1.1.4 A front window is to be equipped.
- 1.1.5 An mechanically operated rain wiper blade on the window is to be equipped at the normal

bridge Conning Position 1, 2, 3, 4 and 5.

1.1.6 Conning Position 1 is located directly behind and close to the forward center wheelhouse window.

1.1.7 Conning Position 2 and 3 are located to port and starboard of Conning Position 1, directly behind and close to the nearest window thereto that provides a clear unobstructed view ahead.

1.1.8 Conning Position 4 and 5 are located at the extreme end of the port bridge wing and starboard bridge wing and must provide a clear and unobstructed view fore and aft of the vessel's port side (Conning Position 4) and the vessel's starboard side (Conning Position 5). The close approach to Conning Position 4 and 5 is to be equipped with safety protection measures.

1.1.9 A minimum of 1.0 meters clearance from consoles or obstructions should be provided in these areas.

1.1.10 For enclosed bridge wings:

1.1.10.1 An opening type window is to be fitted on the outboard bulkhead of each bridge wing to allow the pilot to view the waterline all along the side of the vessel; or

1.1.10.2 When catwalks are fitted that extend to the maximum beam of the vessel, a 2.134 m high by 0.915 m wide door should be provided on the outboard bulkhead of each bridge wing in order to allow the pilot to step out onto the catwalk and look over the railing to view the waterline all along the side of the vessel.

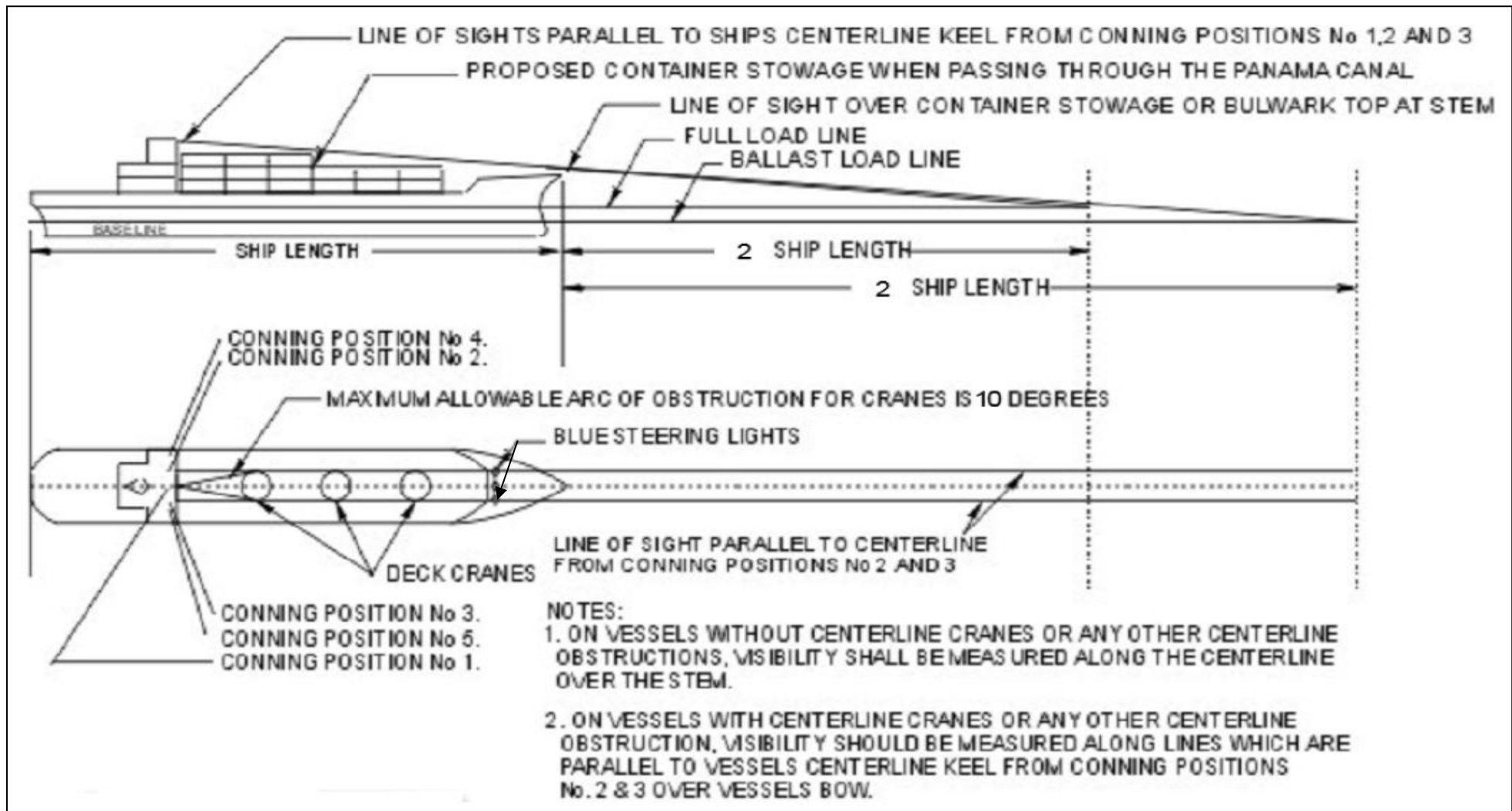

Figure 1.1 Normal conning positions

1.2 Bridge wings

1.2.1 Bridge wings shall extend to the maximum beam of the vessel and provide an obstructed passageway of at least 1.2 m in width along their forward portions from the wheelhouse doors to the extreme ends of the bridge wings.

1.2.2 If it is impossible to extend these bridge wings the full breadth of the vessel, portable or swing-out platforms shall be provided.

1.2.2.1 The portable or swing-out platforms shall extend to the maximum beam of the vessel. They are of adequate size, strength and rigidity to hold two persons and are equipped with horizontal safety handrails and a toe board around the deck, 10 cm high minimum.

1.3 Electric installation

1.3.1 Steering light

(1) All vessels over 100 m (328 feet) in length shall have installed, at or near the stem, a steering range equipped with a fixed blue light which shall be clearly visible from the bridge along the centerline. The height of the light is to be as close as possible to the height of eye level on the bridge. If said range and light so placed would be partially or completely obscured from Conning Position 1, then two such ranges and lights must be installed ahead of Conning Positions 2 and 3. The wheelhouse position directly aft of the steering lights shall be marked with a small labeled plaque on the window sill which can be located in the dark by feel.

(2) The light required shall be capable of being illuminated and extinguished by a suitable rheostat or control switch located either on the navigation bridge or forecastle deck, or both.

1.3.2 Bridge wing spotlights

A spotlight or searchlight capable of illuminating the side of the vessel at the waterline is required to be fitted at the extreme end of each bridge wing on all vessels whose maximum beam is 30 m (98.4 feet) and over. For all vessels, such lights should be of the hinged type and located on the after portion of the bridge wing to allow them to be swung out of the way behind the bridge wing when not in use, or mounted below the bulwark if fitted forward. The normal work position of the pilot on the bridge wing is at the forward outboard corner where he can look forward and down, as

well as over the side and aft. Lights, bearing repeaters and other equipment must not interfere with the pilot's ability to do that.

1.3.3 Whistle controls

(1) On all vessels, one within easy reach on the navigational bridge from Conning Positions 1, 2 and 3, preferably on the forward bulkhead.

(2) If the beam of the vessel is over 15 m, additional controls shall be provided within 1.5 m of the extreme end of bridge wings at Conning Positions 4 and 5.

1.3.4 Bow/stern thrusters

Vessels equipped with bow/stern thrusters should provide controls located at the extreme ends of the bridge wings, as well as inside the wheelhouse.

1.4 Communication equipment

1.4.1 Very High Frequency (VHF) Radio

(1) VHF Radio should at least be capable of working on International Channels 12 (156.00 MHz), 13 (156.650 MHz) and 16 (156.800 MHz).

(2) VHF Radio can be operable from the navigational bridge and located near Conning Position 1.

1.5 Navigational equipment

1.5.1 Compass

(1) Ships of 150 gross tonnage and over shall be fitted with a standard magnetic compass and with a steering compass unless the information provided by the standard compass is made available and is clearly readable by the helmsman at Conning Position 1. Residual deviation of the magnetic compass must be verified to be less than 7 degrees. Such verification by a recognized calibration authority must have been accomplished, and an accurate deviation table issued, within the previous 12-month period. Ships of less than 150 gross tonnage shall be fitted with a steering compass and have means for taking bearings.

(2) Ships of 500 gross tonnage and over shall be fitted with a gyro compass. The master gyro compass or a gyro repeater shall be clearly readable by the helmsman from the main conning position. On ships of 1,600 gross tonnage and over, a gyro repeater or gyro repeaters shall be

provided and shall be suitably placed for taking bearings as nearly as practicable over an arc of the horizon of 360°. A gyro repeater shall be provided which shall be readily visible and usable by the pilot from Conning Position 1.

1.5.2 Automatic Identification System (AIS)

(1) All vessels over 300 gross tons or over 20 meters LOA must be equipped with an AIS transponder that meets the standards set by the International Maritime Organization (IMO). With regard to combined and multiple units (tug-and-tows), only the tug will be required to be equipped with an AIS transponder.

(2) The AIS equipment shall be type-approved according to standard IEC 61993-2. The AIS equipment shall be installed according to IMO “*Guideline for Installation of Ship borne Automatic Identification System (AIS)*”, including the installation of a Pilot Plug. The Pilot Plug shall be close to conning position No. 1 on the navigation bridge. This plug shall be labeled “AIS PILOT PLUG”, and shall have nearby a USA standard (NEMA5-15R) 120V, AC, 3-prong power receptacle, to provide power to the pilot’s laptop computer. This receptacle shall be connected to emergency power.

(3) In addition, the Panama Canal will make an exception with older ships that only have 100VAC to 110VAC electrical service available on the bridge, instead of the required 120VAC, as well as those vessels that have a 2-prong USA standard electrical outlet, instead of the required 3-prong outlet. This lower voltage and type of outlet (NEMA 1-15R) will be acceptable; however, the Canal will not accept vessels with 220-240VAC electrical service.

1.5.3 Rudder angle indicators

For all vessels over 150 feet (45.72 m) in length, the rudder angle indicators provided shall also meet the following requirements:

(1) On vessels less than 80 feet (24.38 m) in beam, at least one rudder angle indicator shall be equipped;

(2) On vessels 80 feet (24.38 m) or more in beam, at least one inside the wheelhouse and one on each bridge wing;

(3) Rudder angle indicators shall be so placed that it can be easily read at day or night from all normal conning positions and from the steering station. Indicators located aft of the conning positions will not be considered as meeting this requirement. In addition, overhead rudder angle

indicators located behind the pilot's conning positions are not acceptable. Rudder angle indicators mounted on overhead panels should be located as close to the forward bulkhead as possible for most efficient viewing by the pilot.

1.5.4 Propeller revolution tachometer indicators

Propeller revolution tachometer indicators provided on vessels over 150 feet (45.72 m) in length overall shall also meet the following requirements:

- (1) On vessels less than 80 feet (24.38 m) in beam, at least one such indicator shall be equipped for each propeller;
- (2) On vessels 80 feet (24.38 m) or more in beam, such indicators are needed inside the wheelhouse and on both bridge wings;
- (3) Indicators shall show revolutions per minute clearly and shall accurately indicate the direction of the propeller or propellers. It shall be noted that indicators located aft of the conning positions will not be considered as meeting this requirement.

1.5.5 Controllable pitch propeller indicators

Controllable pitch propeller indicators provided on vessels over 150 feet (45.72 m) in length overall shall also meet the following requirements:

- (1) On vessels less than 80 feet (24.38 m) in beam, at least one such indicator shall be equipped for each propeller;
- (2) On vessels 80 feet (24.38 m) or more in beam, such indicators are needed inside the wheelhouse and on both bridge wings.

2 Construction, number and location of chocks and bitts

2.1 Vessels under 60.96 m in length and less than 15.24 m in beam

($L < 60.96 \text{ m} \& B \leq 15.24 \text{ m}$)

2.1.1 A double chock or two single chocks at the stem and stern. If the vessel is equipped with the two single chocks, they shall be placed at, port and starboard, not more than 2.5 m abaft the stem or 3 m forward of the stern, and not more than 3 m off the center line.

2.2 Vessels from 60.96 m to 121.92 m in length and not exceeding 22.86 m in beam

($60.96 \text{ m} \leq L < 121.92 \text{ m} \& B \leq 22.86 \text{ m}$)

2.2.1 A double chock at the stem and at the stern or two single chocks at the bow and stern, port and starboard, not more than 2.5 m abaft the stem or 3 m forward of the stern and not more than 3 m off the center line.

2.2.2 Two additional single chocks, port and starboard, 9 to 16 m abaft the stem and 9 to 16 m forward the stern.

2.3 Vessels from 121.92 m to 173.74 m long and not more than 22.86 m in beam

($121.92 \leq L < 173.74 \text{ m} \& B \leq 22.86 \text{ m}$)

2.3.1 A double chock at the stem and at the stern or two single chocks at the bow and stern, port and starboard, not more than 2.5 m abaft the stem or 3 m forward of the stern and not more than 3 m off the center line.

2.3.2 In addition, these vessels shall have a double chock, port and starboard, 12 to 16 m abaft the stem; a single chock port and starboard, 24 m to 28 m abaft the stem.

2.3.3 These vessels shall have a single chock, port and starboard, 12 m to 16 m forward of the stern.

2.4 Vessels over 173.73 m long or 22.86 m in beam or over

($L \geq 173.74 \text{ m} / B \geq 22.86 \text{ m}$)

2.4.1 A double chock at the stem and at the stern or two double chocks at the bow and stern, port and starboard, not more than 2.5 m abaft the stem or 3 m forward of the stern and not more than 3 m off the center line.

2.4.2 These vessels shall have a double chock, port and starboard, 12 to 16 m abaft the stem; a single chock port and starboard, 24 m to 28 m abaft the stem.

2.4.3 These vessels shall have a double chock, port and starboard, 12 to 16 m forward of the stern; a single chock port and starboard, 24 m to 28 m forward of the stern.

2.4.4 Vessels with large flared bows, pronounced counters astern or unusually high freeboard, such as container vessels or vehicle carriers, will be equipped to provide single closed chocks located further aft/forward, respectively, than those required above for correct positioning of assisting tugs or may be required to fit recessed tug bollards.

2.5 Vessels with a maximum beam of 27.73 m or more

($B \geq 27.73 \text{ m}$)

2.5.1 Two additional single chocks shall be provided on the stern. One chock shall be to port of the centerline and one chock shall be to starboard of the centerline. The single chocks shall be symmetrically spaced not less than 3 m nor more than 6 m from the centerline.

2.6 Vessels over 274.32 m in length with maximum beam of 27.73 m or more extending to the stern

($L > 274.32 \text{ m} \ \& \ B \geq 27.73 \text{ m}$)

2.6.1 The double chocks required on port and starboard, 12 to 16 m forward of the stern, shall be located no less than 13 m above the waterline at the maximum Panama Canal fresh water draft of the vessel.

2.7 Single chocks and double chocks shall be of approved types which are specifically used for transiting the Panama Canal.

2.7.1 Single chocks shall have a throat opening of not less than 650 cm² in area, preferred

dimensions are 12×9 inches (305×230 mm), and shall be capable of withstanding a SWL of 45.36t/ 445kN.

2.7.2 Double chocks shall have a throat opening of not less than 900 cm² in area, preferred dimensions are 14×10 inches (355×255 mm), and shall be capable of withstanding a SWL of 64t/ 628kN.

2.8 Bitt provided for each single chock

2.8.1 Each single chock shall have an accompanying bitt, preferred diameter of 356 mm, capable of withstanding the stress caused by a SWL of 45.36t/445kN.

2.9 Bitt provided for each double chock located at the stem and the stern as required

2.9.1 Each double chock shall have two pairs of accompanying heavy bitts with each bitt of each pair, preferred diameter of 406 mm, capable of withstanding the stress caused by a SWL of 64t/628kN.

2.10 Bitt provided for other double chocks

2.10.1 Other double chocks shall have a pair of accompanying heavy bitts with each bitt capable of withstanding a SWL of 64t/628kN.

2.11 Chocks for towing wires

2.11.1 All chocks for towing wires shall be of heavy closed construction and shall have a convex bearing surface with a radius of not less than 180 mm. The convex surface shall extend so that a wire from the bitt, or from the locks locomotive through the chock, shall be tangent to the 180 mm radius at any angle up to 90 degrees with respect to a straight line through the chock.

2.11.2 No part of the vessel which may be contacted by the towing wires, at any angle, shall have less than 180 mm radius.

2.12 Where recessed hull bitts are installed in the hull

2.12.1 Bitts shall be installed not less than 3.7 m and not more than 4.6 m above the vessel's waterline.

2.12.2 The recessed hull bitts are to be installed in the hull as far forward as possible, both port and starboard sides, where the bow flare does not exceed 25 degrees as measured from the vertical line of the vessel's side.

2.12.3 Vessels that have an appreciable variation in draft are required to install two sets of recessed hull bitts so that one bitt is located over the other bitt.

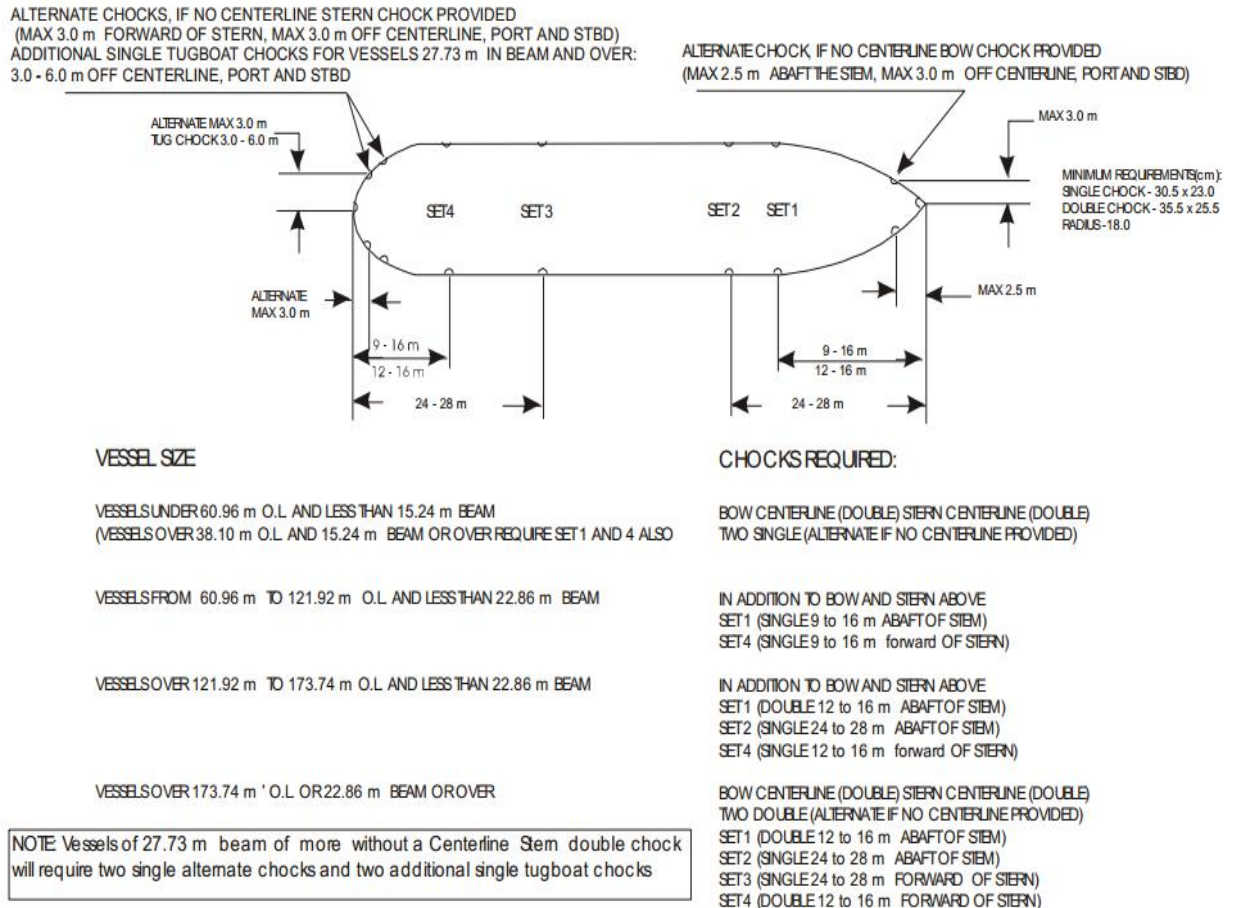

Figure 2.1 Location of Chocks and Bitts

2.13 Neopanamax and Panamax Plus Vessels

2.13.1 Vessels shall have a double chock (for mooring) at the stem and stern or two double chocks at the bow and stern, port and starboard, not more than 2.5 m abaft the stem or 3.0 m forward of the stern and not more than 3.0 m off the centerline.

2.13.2 These vessels shall have double chocks and a pair of heavy bitts (SET 1 mooring), port and starboard, 2.5 to 16 m abaft the stem and each bitt shall be capable of withstanding a SWL of 64t/628KN.

2.13.3 These vessels shall have double chocks and a pair of heavy bitts (SET 4 mooring), port and starboard, 3 to 16 m forward of the stern and each bitt shall be capable of withstanding a SWL of 64t/628KN.

2.13.4 Vessels shall have double chocks and a pair of heavy bitts at the bow and stern about 3 to 14 m off the centerline, port and starboard sides with a preferred diameter of 500 millimeters (with additional tugboat chocks). Each bitt shall be capable of withstanding the stress caused by a SWL of 90t/883KN.

2.13.5 These vessels shall have double chocks and a pair of heavy bitts (SET 2 towing), port and starboard, 16 to 70 m abaft the stem and each bitt shall be capable of withstanding a SWL of 90t/883kN.

2.13.6 These vessels shall have double chocks and a pair of heavy bitts (SET 3 towing), port and starboard, 16 to 60 m forward of the stern and each bitt shall be capable of withstanding a SWL of 90t/883kN.

2.13.7 The rest of the chock locations for use in mooring operations shall be accompanied by one pair of heavy bitts meeting the minimum SWL of 64t/628 kN.

2.13.8 As for PANAMAX PLUS and Neo PANAMAX vessels: the throat opening area of double chocks shall be not less than 900 cm² with a preferred dimension of 14×10 inches (355mm×255mm). The SWL in towing operations shall be 90t /883kN while the SWL in mooring operations from any direction shall be 64t/628kN.

2.13.9 Vessels with large flared bows, pronounced counters or unusually high freeboards, such as LNG carriers, container vessels, cruise vessels or vehicle carriers, will be required to provide closed chocks located aft/forward, respectively, than those required for SET2/SET3 above for

correct positioning of assisting tugs. These vessels may be required to fit recessed tug bollards into the hull in lieu of the chocks. Recessed bits shall meet the 90 tons SWL required.

2.13.10 All vessels wishing to transit the new locks will be required to have mooring winches in operation and fitted with manila or synthetic mooring lines before every transit to be used during mooring operations at the new locks. Note that “Ropes, composed of wire, fiber or filaments, are not acceptable for Canal operations and shall not be used”. The normal procedure in the new locks will be to use the manila or synthetic mooring lines from the vessel’s winch drums. The mooring fittings that will be used for mooring at the locks will be the chocks located at the bow/stern centerline or SET 1 and SET 4.

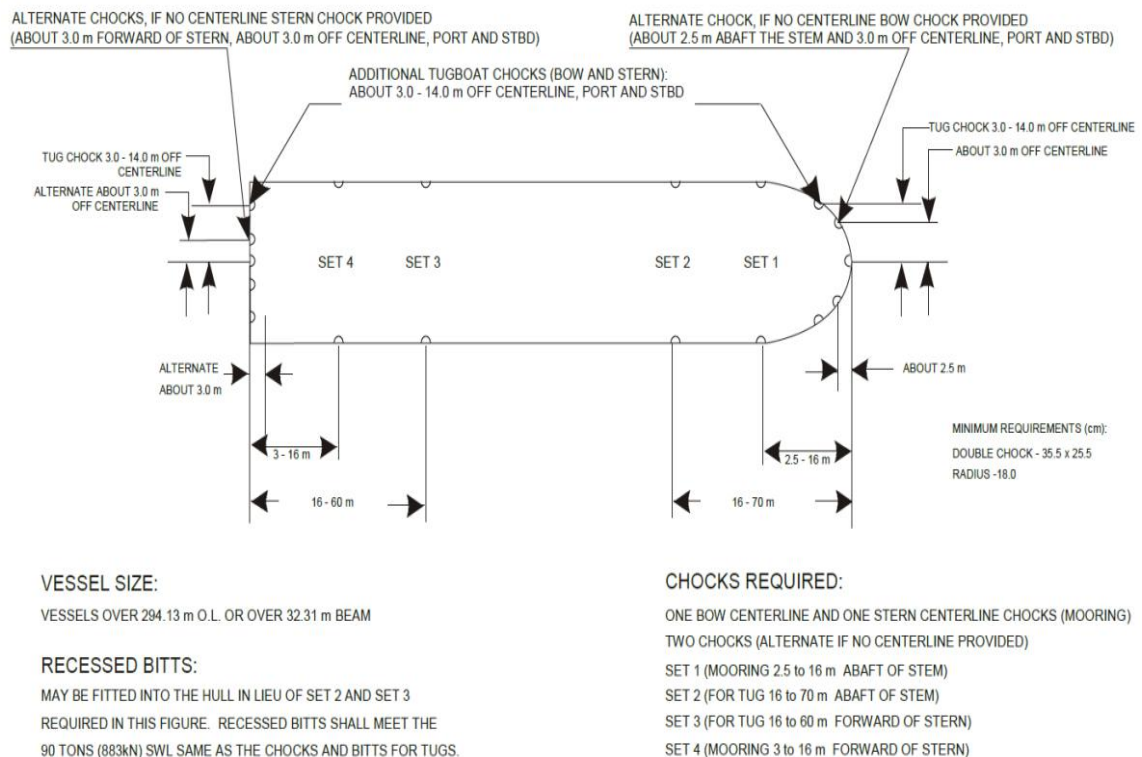

Figure 2.2 Location of Chocks and Bitts (Neopanamax and Panamax Plus)

3 Requirement for pilot platforms and shelters on certain vessels

3.1 General provisions

As required by Article 64 of the ACP Navigation Regulations, suitable platforms and shelters must be provided by certain vessels^⑤ for assisting pilots. Control pilots will position assisting pilots where they can best contribute to vessel control, which may be at any of the existing pilot platform locations:

(1) Vessels with the bridge in the extreme after part of the vessel (assisting pilot platforms will normally be forward).

(2) Vessels with the bridge in the extreme forepart of the vessel (assisting pilot platforms will normally be aft).

3.2 Pilot platform and shelter

3.2.1 Platforms must afford suitable shelter to protect assisting pilots from rain and sun.

3.2.2 Each platform is to be erected directly over the furthest point forward of the extreme beam at the waterline and not more than 6 inches (152 mm) inboard from the outside of the vertical plane of the shell plating. For vessels where the bridge is located forward, these pilot platform shelters will be required to be erected directly over that position which is the furthest point aft of the extreme beam at the waterline and not more than 6 inches (152 mm) inboard from the outside surface of the vertical plane of the shell plating.

3.2.3 All vessels whose extreme beam is 24.38 m or more are required to provide bridge wing shelter platforms for the protection of control pilots at Conning Positions No. 4 and 5.

3.2.4 The awning is to be made of suitable materials to provide shelter from the sun and rain. The deck of pilot platforms shall be made of wood or other material with non-skid surface, sufficient to dry footing at all times. Overhead awning should be rigged to avoid spilling water inside the framework of the shelter during rain.

⑤ The Canal Authority may require the installation of pilot platforms based on the design and size of the ship, the location of the navigation bridge and the number of pilots needed.

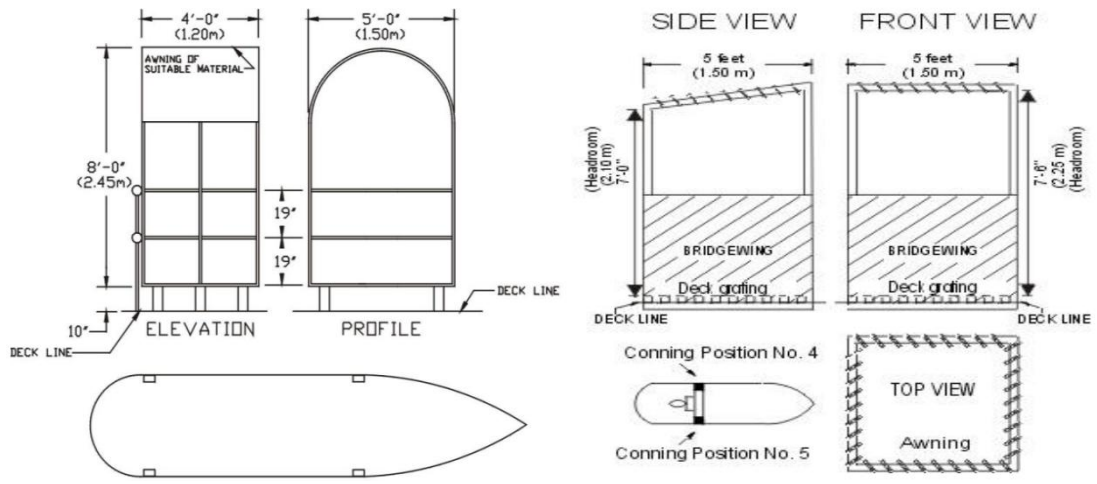

Figure 3.1 Pilot platforms and shelters

4 Pilot transfer arrangements

Safe and convenient access to, and egress from, the either side of the ship shall be provided. Mechanical pilot hoists are not accepted.

4.1 Accommodation ladders

4.1.1 Accommodation ladders should be sited leading aft, that is, with the lower platform at the after end. Accommodation ladders sited leading afore or ladders not firmly secured to the ship's side are considered not suitable for the safe use by the Panama Canal Authority. When in use, the lower platform of accommodation ladders shall rest firmly against the ship's side within the parallel mid-body of the ship and within the mid-ship half-length and clear of all discharges. A pilot ladder shall always be kept on deck adjacent to the lift and available for immediate use.

4.1.2 The lower platform of the accommodation ladder shall be kept in a horizontal position when in use, with the boat spar extended, and it should be held at the same height above the water as the deck of the pilot boat. Intermediate platforms, if so fitted, shall be self-leveling. Treads and steps of the accommodation ladder should be so designed that an adequate a safe foothold is provided at all operating angles.

4.1.3 The ladder and platforms shall have vertical safety stanchions and rails or lines equipped and rigged on both sides. If hand ropes are used, they should be tight and properly secured. The vertical space between the handrail or hand rope and the stringers of the ladder should be securely fenced.

4.1.4 The length of an accommodation ladder used in combination with a pilot ladder as a 9-meter rig should be sufficient to ensure that its angle of slope doesn't exceed 55 degrees. The pilot ladder should be rigged immediately adjacent to the lower platform of the accommodation ladder and be secured at the edge of the lower platform with the pilot ladder hanging vertically. The pilot ladder should extend at least 2 m (6 feet 8 inches) above the lower platform and shall rest firmly against the ship's side within the parallel mid-body of the ship and, as far as is practicable, within the mid-ship half-length and clear of all discharges. The lower platform must be held at a level to allow for the height of the launch deck, plus the height of a person standing on the deck, plus the rise and fall due to swell; normally, 7 m (23 feet) above the water is sufficient.

4.1.5 Lighting shall be provided at night such that the full length of the ladder is adequately lit.

4.1.6 If a trap door is fitted in the lower platform of a combination ladder arrangement to allow access from and to the pilot ladder, the aperture should not be less than 750 mm × 750 mm (30 inches × 30 inches) and of a design approved by the Authority. The pilot ladder should extend above the lower platform at least 2 m (6 feet 8 inches). The aperture on the lower platform must be open to the side of the vessel's hull to allow the pilot ladder to lay flat against the hull.

4.1.7 Accommodation ladders, together with any suspension arrangements or attachments fitted and intended for use in the Canal, must be arranged to the satisfaction of the Panama Canal Authority.

4.2 Pilot ladders

4.2.1 The pilot ladder shall be certified by the manufacturer as complying with this regulation or with an international standard acceptable to the Panama Canal Authority. Ladders shall be inspected in accordance with SOLAS regulations I/6, 7 and 8.

4.2.2 All pilot ladders used for pilot transfer shall be clearly identified with tags or other permanent marking so as to enable identification of each appliance for the purpose of survey, inspection, and record keeping. A record shall be kept on the ship as to the date the identified ladder is placed into service and any repairs effected.

4.2.3 The ladder shall be safe, convenient and efficient for the purpose of enabling the pilots to embark and disembark safely, kept clean and in good order and may be used by officials or other persons while a ship is arriving or leaving a port.

4.2.4 The ladder shall require a climb of not less than 1.5 m (5 feet) and not more than 9 m (30 feet) above the surface of the water.

4.2.5 The ladder shall be so positioned that it is clear from any possible discharges from the ship, that it is within the parallel mid-body length of the ship and, as far as is practicable, within the mid-ship half-length of the ship.

4.2.6 Each step shall rest firmly against the ship's side; where constructional features, such as rubbing bands, would prevent the implementation of this provision, special arrangements shall be made to the satisfaction of the Authority to ensure that persons are able to embark and disembark

safely.

4.2.7 Single length of ladder shall be used capable of reaching the water from the point of access to, or egress from, the ship; in providing for this, due allowance shall be made for all conditions of loading and trim of the ship and for an adverse list of 15 degrees. Whenever the distance from sea level to the point of access to the ship is more than 9 m (30 feet), access from the pilot ladder to the ship shall be by means of an accommodation ladder or other equally safe and convenient means.

4.2.8 The securing strong points, shackles and securing ropes shall be at least as strong as the side ropes.

4.2.9 The steps of the pilot ladder shall comply with the following requirements:

- (1) If made of hardwood, they should be made in one piece, free of knots or other defects. If made of material other than hardwood, they should be of equivalent strength, stiffness and durability to the satisfaction of the Authority.
- (2) The four lowest steps may be made of rubber of sufficient strength and stiffness or other material to the satisfaction of the Authority.
- (3) Steps shall have an efficient non-slip surface, and shall not be painted with an opaque color or high gloss paint. The grain and character of the step shall be visible in order that any cracks or defects may be readily visible to the person using the ladder.
- (4) Should have not less than 406 mm (16 inches) between the inside surfaces of the side ropes. Steps should be not less than 115 mm (4.5 inches) wide, and 25 mm (1 inch) in depth, excluding any non-slip device or grooving.
- (5) Should be equally spaced not less than 305 mm (12 inches) nor more than 380 mm (15 inches) apart and be secured in such a manner that each will remain horizontal.

4.2.10 No pilot ladder shall have more than two replacement steps which are secured in position by a method different from that used in the original construction of the ladder, and any steps so secured shall be replaced as soon as reasonably practicable by steps secured at position by the method used in the original construction of the ladder. When any replacement step secured to the side ropes of the ladder by means of grooves in the sides of the steps, such grooves shall be in the longer sides of the steps.

4.2.11 Pilot ladder with more than five steps should have spreader steps not less than 1.8 m (6

feet) long provided that such intervals as will prevent the pilot ladder from twisting. Such spreader steps or battens shall be made of the same material and construction as the other ladders steps. The lowest spreader step shall be on the fifth step from the bottom of the ladder and the interval between any spreader step and the next shall not exceed nine steps.

4.2.12 The side ropes of the ladder shall consist of two uncovered ropes not less than 20 mm (3/4 inch) in diameter on each side. Each rope shall be continuous with no joints below the top step. Two manropes properly secured to the ship and between 28 mm (1 inch) and 32 mm (1.3 inch) in diameter shall be ready for immediate use if required by the pilot.

4.2.13 Man-ropes shall be fixed at the rope end to the ring plate fixed on deck and shall be ready for use when the pilot disembarks, not upon request from the pilot approaching to board (the manropes shall reach the height of the stanchions or bulwarks at the point of access to the deck before terminating at the ring plate on deck).

4.2.14 Side ropes shall be made of manila or other material of equivalent strength, durability and grip that has been protected against actinic degradation and is satisfactory to the Authority.

4.2.15 A life buoy equipped with a self-igniting light should be kept at hand ready for use, as should a heaving line. Life buoys should not be attached to the ship.

4.2.16 Lighting should be provided such that both the pilot ladder over side and the position where any person embarks or disembarks on the ship are adequate lit.

4.3 Ship side doors

Ship side doors used for pilot transfer shall not open outward. The point of ingress or egress must be no less than 1.5 m (5 feet) above the surface of the water. The door opening shall not be less than 1.5 m (5 feet) wide and 2.2 m (7.2 feet) tall.

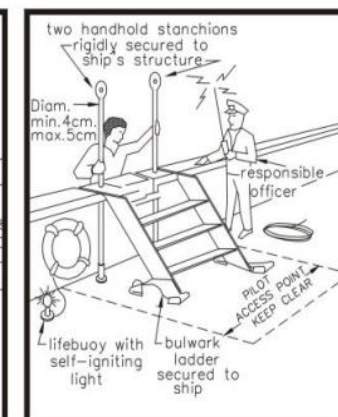
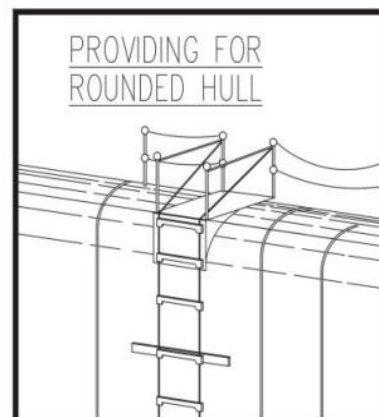
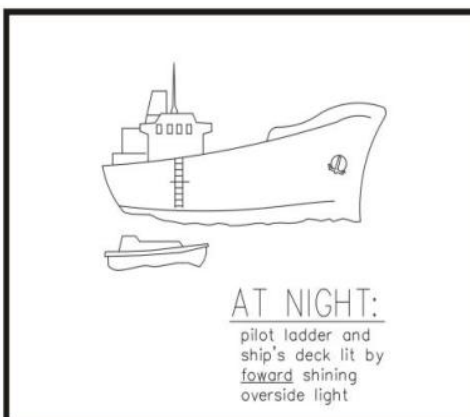
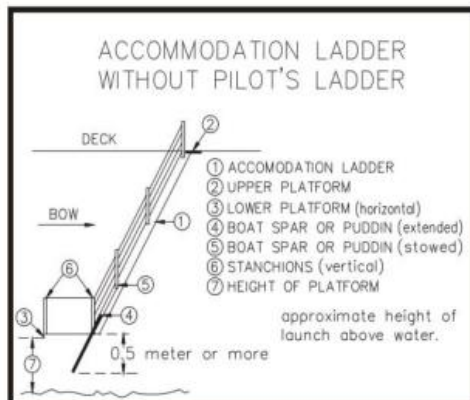
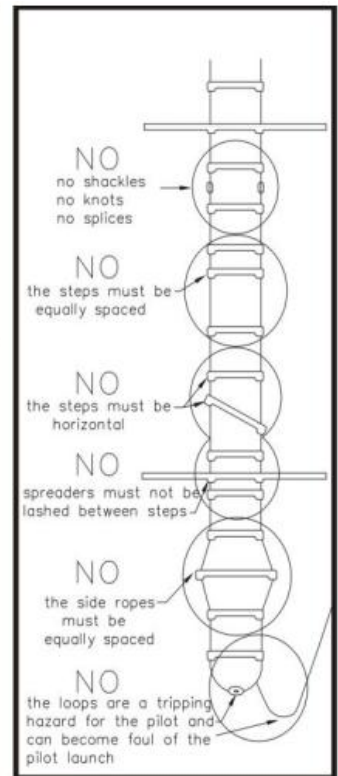
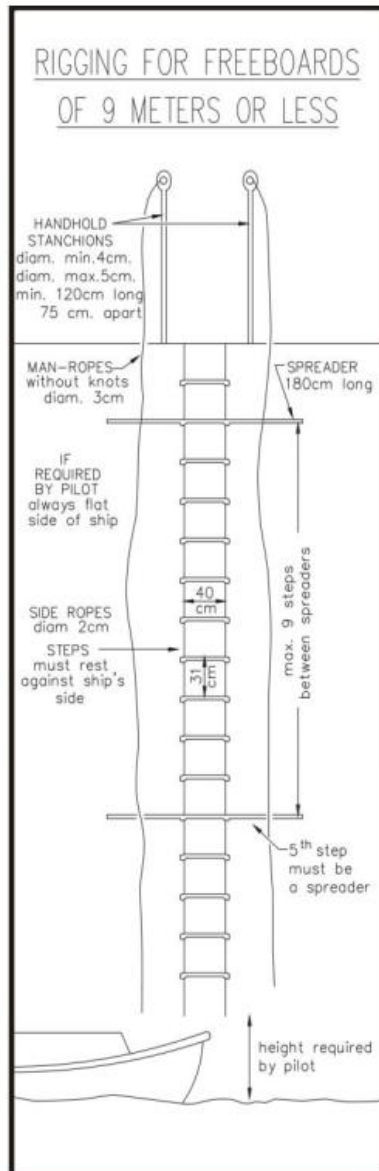
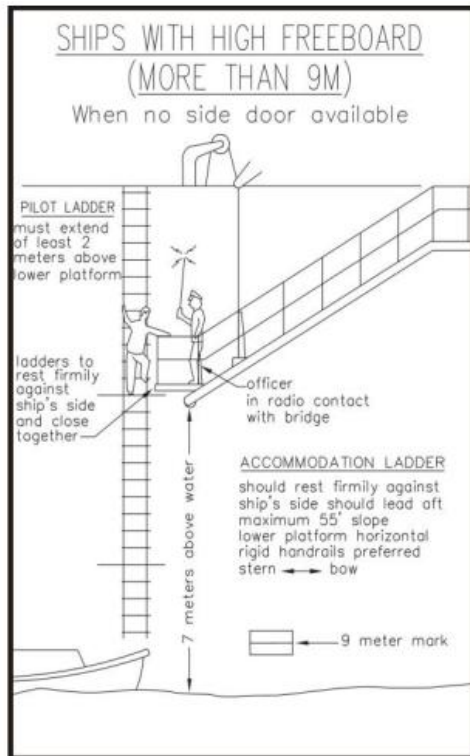

Figure 4.1 Pilot ladders

5 Miscellaneous

5.1 Deck machinery

5.1.1 The tensile force of deck machinery is recommended to be verified onboard the ship.

5.1.2 Capstans or mooring winches' warping heads used to assist in heaving these 13 mm lines shall be capable of pulling these lines at a rate of 120 feet (37 m) per minute.

5.1.3 Anchors shall be retrieved at a rate of 3 minutes per knot.

5.1.4 Winches at the stem and stern shall be capable of pulling wire ropes at a rate of at least 37 m per minute.

5.1.5 For any part extending beyond the hull, it shall be determined whether it is permanent or temporary.

5.1.6 There are 12 mooring lines (6 at the stem/6 at the stern). Each line shall be at least 100 m in length and shall have an eye of at least 1.5 m spliced in one end. Wire ropes are not acceptable for mooring lines.

5.2 Response time ahead or astern for transiting vessels

Notwithstanding that the propulsion is controlled from the bridge or the engine room, the maximum response time ahead or astern for transiting vessels shall not exceed 10 seconds.

**Annex Declaration of Survey Regarding Compliance with Requirements for Ship
Construction and Equipment of the Panama Canal**



Form SOC(ACP-CTR)

No. _____

中国船级社
CHINA CLASSIFICATION SOCIETY

**DECLARATION OF SURVEY REGARDING COMPLIANCE WITH THE PANAMA
CANAL SHIP ARRANGEMENT AND EQUIPMENT REQUIREMENTS**

Name of Ship _____
Distinctive Number or Letters _____
Port of Registry _____
Gross Tonnage (ITC69) _____
IMO No. _____
CCS No. _____
Date on which keel was laid _____

This is to confirm that survey of the above vessel has been carried out - including examination of Drawings - upon request from the Yard and/or Owner in order to facilitate determination of the above Vessel's compliance with the Panama Canal Commission's(P.C.C), Vessel Arrangement and Equipment Requirements.

It should be noted that P.C.C is the only entity to evaluate, approve or disapprove vessels for transit, and it is their prerogative to require additional evidence / inspections of the vessel and equipment installed.

This declaration is not issued on behalf of Panama Canal Commission, but indicates compliance with CCS's understanding of their requirements.

It was found that – as far as could be seen – the vessel complies with the “ACP OP NOTICE TO SHIPPING” requirements w.r.t.: - Part 3, “Pilot Platforms and Shelters”, Part4, “Navigation Bridge Features required for Transiting Vessels” and Part 8, “Construction, Number and Location of Chocks and Bitts” - according to scope of work on the enclosed survey report as below.

Remark:

A Panama Canal SOPEP(PCSOPEP) to be provided and submitted for its initial review by the ACP in advance of vessel's first arrival in Panama Canal Waters(applicable for vessels carrying 400 metric tons or more of oil as cargo and/or fuel).

Issued at _____ (_____)

Issued on _____ Surveyor to CHINA CLASSIFICATION SOCIETY



**SURVEY REPORT FORM FOR COMPLIANCE WITH REQUIRED SHIP
ARRANGEMENT AND EQUIPMENT FOR TRANSITING THE PANAMA CANAL**

No. _____

The survey has been carried out upon request from the Yard and / or Owner. The Panama Canal Commission is the only entity authorized to evaluate, approve or disapprove vessels for Canal transit requirements.

Name of Ship _____

Port of Registry _____

IMO No. _____

Date on which keel was laid _____

Overall Length _____

Breadth(beam) _____

Height above waterline¹ _____

Draft² _____

- | | |
|---|--|
| 1 | Maximum height above waterline 57.91 m |
| 2 | Draft min. and draft max. value allowable for transiting |

Items	
1.0	General / Type of Vessel
1.1	PANAMAX : 289.6 meters in length by 32.31 meters in beam by up to 12.04 meters TFW draft <input type="checkbox"/> (Passenger and container ships may be up to 294.13meters).
1.2	PANAMAX PLUS : Panamax vessel with TFW draft above 12.04 up to 15.20 meters and approved for transit of new locks. <input type="checkbox"/>
1.3	Neo PANAMAX : All vessels with dimensions greater than Panamax and Panamax Plus that comply with the size and draft limitations for the new locks. 366 meters in length by 49 meters in beam by 15.2 meters TFW draft. <input type="checkbox"/>
1.4	OP notice to shipping used for survey No. N01-20XX <input type="checkbox"/>
1.5	List drawings used in connection with survey:
No.	Title
	Review date
	Towing and Mooring Arrangement
	Wheelhouse Arrangement
	Mast & Signals Arrangement

Pilot Platform and Shelters Arrangement

Pilot Transfer Arrangements

1.6	Vessel built in compliance with SOLAS and provided with SOLAS certificates.	<input type="checkbox"/>
2.	Wheelhouse	
2.1	Windows of sufficient size and number to provide a clear view?	<input type="checkbox"/>
2.2	Of clear safety glass?	<input type="checkbox"/>
	Tinted windows, if any, movable?	<input type="checkbox"/>
2.3	Centre window arranged?	<input type="checkbox"/>
2.4	Mechanically operated rain wiper blades on windows at the normal bridge conning positions referred to below?	<input type="checkbox"/>
2.4.1	Conning position No. 1 is located directly behind and close to the forward center wheelhouse window?	<input type="checkbox"/>
2.4.2	Conning position No. 2 and No. 3 are located to port and stbd. of position No. 1 respectively, and directly behind and close to the nearest window thereto that provides a clear unobstructed view ahead?	<input type="checkbox"/>
2.4.3	Conning positions No. 4 and No. 5 are located at the extreme ends of the port and starboard bridge wings and must provide a clear and unobstructed view fore and aft of the vessel's sides. No equipment, instrumentation or inset navigation lights shall block the pilots approach to the forward and after portion of the bridge ends. Are the close approaches safeguarded?	<input type="checkbox"/>
2.4.4	Is there at any position a minimum of 1 meter clearance from consoles or obstructions provided?	<input type="checkbox"/>
2.4.5	For vessels equipped with bow/stern thrusters these should be provided with controls at the extreme ends of the bridge wings?	<input type="checkbox"/>
2.4.6	In case of enclosed bridge wings:	
2.4.6.1	Is an opening type window fitted on the outward bulkhead of each bridge wing in order to allow the pilot to view the waterline all along the side of the vessel?	<input type="checkbox"/>
2.4.6.2	When catwalks are fitted that extend to the maximum beam of the vessel: Is a wide door (of at least 0.915m width and 2.134m height) provided on the outward bulkhead of each bridge wing in order to allow the pilot to step out onto the catwalk and look over the railing to view the waterline all along the side of the vessel?	<input type="checkbox"/>
3.	Bridge indicators	
	All vessels over 45.72 m (150 feet) in length shall be provided with:	
3.1	Rudder angle indicators as follows:	
3.1.1	(a) On vessels less than 24.38 m (80 feet) in beam, at least one of such design and placement that it can be easily read by day or night from all normal conning positions and from the steering station.	<input type="checkbox"/>
3.1.2	(b) On vessels 24.38 m (80 feet) or more in beam, at least one inside the wheelhouse and one on each bridge wing, of such design and placement so that at least one can be easily read by day or night from each conning position and from the steering station.	<input type="checkbox"/>
3.1.3	(c) They shall show in degrees clearly and accurately the position and direction of the rudder or rudders. It shall be noted that indicators located aft of the conning positions will not be considered as meeting this requirement. Overhead rudder angle indicators located behind the pilot's conning positions are not acceptable. Rudder angle indicators mounted on overhead panels should be located as close to the forward bulkhead as possible for most efficient viewing by the pilot.	<input type="checkbox"/>
3.2	Propeller revolution tachometer indicators as follows:	
3.2.1	(a) On vessels less than 24.38 m (80 feet) in beam, at least one for each propeller, of such design as to be easily read by day or night from all normal conning positions.	<input type="checkbox"/>
3.2.2	(b) On vessels 24.38 m (80 feet) or more in beam, at least one for each propeller located inside the wheelhouse and one for each propeller located on each bridge wing, of such design and placement so that at least one can be easily read by day or night from each conning position.	<input type="checkbox"/>
3.2.3	(c) Indicators shall show revolutions per minute clearly and shall accurately indicate the direction of the propeller or propellers. It shall be noted that indicators located aft of the conning positions will not be considered as meeting this requirement.	<input type="checkbox"/>
3.2.4	(d) All vessels with variable pitch control indicators will have them so located as required in (a) and (b) of this subsection.	<input type="checkbox"/>

3.3	Controllable pitch propeller indicators as follows:	
3.3.1	(a) On vessels less than 24.38 m (80 feet) in beam, at least one for each propeller, of such design as to be easily read by day or night from all normal conning positions.	<input type="checkbox"/>
3.3.2	(b) On vessels 24.38 m (80 feet) or more in beam, at least one for each propeller located inside the wheelhouse and one for each propeller located on each bridge wing, of such design and placement so that at least one can be easily read by day or night from each conning position.	<input type="checkbox"/>
3.4	(4) Indicators must be operational.	<input type="checkbox"/>
4.	VHF radio	
4.1	Equipped with at least Channels 12 (156.00 MHz), 13 (156.650 MHz) and 16 (156.800 MHz)?	<input type="checkbox"/>
4.2	Operable from the navigational bridge and located near Conning Position No.1?	<input type="checkbox"/>
5.	Whistle control	
5.1	Within easy reach on the navigational bridge from Conning Position Nos. 1, 2 and 3(preferably on the forward bulkhead)?	<input type="checkbox"/>
5.2	If beam over 15 meters, are additional controls provided within 1.5 meters of the extreme end of bridge wings at Conning Position Nos. 4 and 5?	<input type="checkbox"/>
5.3	Is it possible to regulate precisely any required signals?	<input type="checkbox"/>
6.	Bridge wings	
6.1	Do bridge wings extend to the extreme breadth, and provide a clear passage of at least 1.2 meters wide from wheelhouse doors to extreme ends?	<input type="checkbox"/>
6.2	If not, are portable or swing-out platforms provided?	<input type="checkbox"/>
6.2.1	Portable or swing-out platform if any, extended to the full breadth, and be of size, strength and rigidity to hold two persons and equipped with horizontal handrails and a toe board with a minimum 10 cm height?	<input type="checkbox"/>
6.3	A spotlight or searchlight capable of illuminating the side of the vessel at the waterline is required to be fitted at the extreme end of each bridge wing on all vessels whose maximum beam is 30 m (98.4 feet) and over. For all vessels, such lights should be of the hinged type and located on the after portion of the bridge wing to allow them to be swung out of the way behind the bridge wing when not in use, or mounted below the bulwark if fitted forward. The normal work position of the pilot on the bridge wing is at the forward outboard corner where he can look forward and down, as well as over the side and aft. Lights, bearing repeaters and other equipment must not interfere with the pilot's ability to do that.	<input type="checkbox"/>
7.	Ladders	
7.1	Accommodation ladder provided SOLAS V/23?	<input type="checkbox"/>
7.2	Pilot ladder in accordance with the SOLAS requirements.	<input type="checkbox"/>
7.3	Ship side doors used for pilot transfer shall not open outward. The point of ingress or egress must be no less than 1.5 m (5 feet) above the surface of the water. The opening used for embarking or disembarking shall not be less than 1.5 m (5 feet) wide and 2.2 m (7.2 feet) tall.	<input type="checkbox"/>
8.	Miscellaneous	
8.1	If the vessel is over 100 meters in length, is a fixed blue steering light installed at or near the stem and visible from the bridge along the centerline and its height as close as possible to the height of eye level at the bridge?	<input type="checkbox"/>
8.1.1	If direct view ahead at conning position No.1 is obscured two blue steering lights fitted ahead of conning positions Nos. 2 and 3.	<input type="checkbox"/>
8.1.2	The wheelhouse position directly aft of the steering lights shall be marked with a small labeled plaque on the window sill which can be located in the dark by feel.	<input type="checkbox"/>
8.1.3	Suitable control switch located on bridge or forecandle or both?	<input type="checkbox"/>
8.2.1	For vessels with max. beam of 30 meters or more: Is a spotlight or a searchlight located on the after portion of the extreme end of each bridge wing or mounted below the bulwark if fitted forward?	<input type="checkbox"/>
8.2.2	Are these lights capable of illuminating the side of vessel and able to be swung out of the way, behind the bridge wing, when not in use?	<input type="checkbox"/>
8.2.3	The normal work position for the pilot is at the outboard corner where he can look forward and down as well as over the side and aft. Are there any lights, bearing repeaters or other equipment obstructing him from doing so?	<input type="checkbox"/>
8.3	Ships of 150 gross tonnage (ITC69) and over shall be fitted with a standard magnetic compass and with a steering compass unless the information provided by the standard compass is made available and is clearly readable by the helmsman at Conning Position No.1.	<input type="checkbox"/>

8.3.1	Means must be available for taking bearings, as nearly as practicable over an arc of the horizon of 360°.	<input type="checkbox"/>
8.3.2	Residual deviation of the magnetic compass must be verified to be less than 7 degrees by swinging the vessel on various headings. Such verification by a recognized calibration authority must have been accomplished, and an accurate deviation table issued, within the previous 12-month period. If necessary, the compass must be adjusted to reduce the observed deviation to less than 7 degrees. Calibration cards issued and signed by the master will be accepted as long as the deviation is less than 6 degrees.	<input type="checkbox"/>
8.3.3	Ships of less than 150 gross tonnage shall be fitted with a steering compass and have means for taking bearings.	<input type="checkbox"/>
8.4	Ships of 500 gross tons (ITC69) and over shall be fitted with a gyro compass. The master gyro compass or a gyro repeater shall be clearly readable by the helmsman from the main conning position. On ships of 1,600 gross tonnage (ITC69) and over, a gyro repeater or gyro repeaters shall be provided and shall be suitably placed for taking bearings as nearly as practicable over an arc of the horizon of 360°. A gyro repeater shall be provided which shall be readily visible and useable by the pilot from Conning Position No.1. Maximum residual steady state gyro error shall not exceed 2°. The maximum divergence in reading between the master compass and repeaters under all operational conditions should not exceed plus or minus 0.5°.	<input type="checkbox"/>
8.5	All vessels over 300 gross tons or over 20 meters LOA must be equipped with an AIS transponder that meets the standards set by the International Maritime Organization(IMO). With regard to combined and multiple units (tug-and-tows), only the tug will be required to be equipped with an AIS transponder.	<input type="checkbox"/>
8.5.1	The AIS system installed onboard vessels shall be Class A AIS ship borne equipment according to IMO MSC 74 (69) Annex 3, "Recommendation on Performance Standards for a Universal Ship borne Automatic Identification Systems (AIS)", as amended.	<input type="checkbox"/>
8.5.2	The AIS equipment shall be type-approved according to standard IEC 61993-2.	<input type="checkbox"/>
8.5.3	The AIS equipment shall be installed according to IMO "Guidelines for Installation of Ship borne Automatic Identification System (AIS)", including the installation of a Pilot Plug. The Pilot Plug shall be close to conning position No. 1 on the navigation bridge. This plug shall be labeled "AIS PILOT PLUG", and shall have nearby a USA standard (NEMA 5-15R)120V, AC, 3-prong power receptacle, to provide power to the pilot's laptop computer. This receptacle shall be connected to emergency power.	<input type="checkbox"/>
8.5.4	In addition, the Panama Canal will make an exception with older ships that only have 100VAC to 110VAC electrical service available on the bridge, instead of the required 120VAC, as well as with those vessels that have a 2-prong USA standard electrical outlet, instead of the required 3-prong outlet. This lower voltage and type of outlet (NEMA 1-15R) will be acceptable; however, the Canal will not accept vessels with 220-240 VAC electrical service.	<input type="checkbox"/>
8.6	Recommend pull in capacity of deck machinery to be verified on board.	<input type="checkbox"/>
8.6.1	All mooring winches shall be capable of retrieving the lines used for pulling the locomotive wires onboard at a rate of 120 feet (37 meters) per minute.	<input type="checkbox"/>
8.6.2	Anchors shall be retrieved at a rate of 3 minutes per shot.	<input type="checkbox"/>
8.7.1	Does anything extend beyond any portion of the hull of the vessel, whether permanent or temporary?	<input type="checkbox"/>
8.7.2	If yes, please specify :	
8.8	Winches fore and aft are capable of retrieving wires with a minimum speed of 37 meters/minute?	<input type="checkbox"/>
8.9	Are a total of 12 mooring lines (6 forward/ 6 aft) each of length at least 100 meters and with an eye of at least 1.5 meters spliced in one end? Wire ropes not accepted.	<input type="checkbox"/>
8.10	Notwithstanding whether the propulsion is controlled from the bridge or the engine room is the response time ahead or astern 10 seconds or less?	<input type="checkbox"/>
9.	Construction, number and location of chocks and bitts	
9.1	For vessel less than 60.96 meters in length and not exceeding 15.24 meters in beam:	
9.1.1	Is there double chock at the stem and stern?	<input type="checkbox"/>
	or two single chocks at the stem and stern, placed port and starboard, not more than 2.5 meters abaft the stem or 3.0 meters forward of the stern, and not more than 3.0 meters off the center line?	<input type="checkbox"/>

9.2	For vessel 60.96 meters to 121.92 meters in length and not exceeding 22.86 meters in beam	
9.2.1	Is there a double chock at the stem and stern? or two single chocks at the stem and stern, placed port and starboard, not more than 2.5 meters abaft the stem or 3.0 meters forward of the stern, and not more than 3.0 meters off the center line?	<input type="checkbox"/>
9.2.2	and in addition two single chocks, placed port and starboard, 9 to 16 meters abaft the stem and 9 to 16 meters forward of the stern?	<input type="checkbox"/>
9.3	For vessel 121.92 meters to 173.74 meters in length and not exceeding 22.86 meters in beam:	
9.3.1	Is there a double chock at the stem and stern? or two single chocks at the stem and stern, placed port and starboard, not more than 2.5 meters abaft the stem or 3.0 meters forward of the stern, and not more than 3.0 meters off the center line?	<input type="checkbox"/>
9.3.2	and in addition a double chock, placed port and starboard, 12 to 16 meters abaft the stem, and a single chock, placed port and starboard, 24 to 28 meters abaft the stem.	<input type="checkbox"/>
9.3.3	and a single chock placed port and starboard, 12 to 16 meters forward of the stern?	<input type="checkbox"/>
9.4	For vessel over 173.74 meters long, or 22.86 meters in beam or over, is there:	<input type="checkbox"/>
9.4.1	A double chock at the stem and stern? or two double chocks at the bow and stern, port and starboard, not more than 8 feet (2.5 m) abaft the stem or 10 feet (3 m) forward of the stern and not more than 10 feet (3 m) off the center line.	<input type="checkbox"/>
9.4.2	a double chock, port and starboard, 12 to 16 meters abaft the stem and a single chock, port and starboard, 24 to 28 meters abaft the stem.	<input type="checkbox"/>
9.4.3	A double chock, port and starboard, 12 to 16 meters forward of the stern and a single chock, port and starboard, 24 to 28 meters forward of the stern?	<input type="checkbox"/>
9.4.4	Vessels with unusually high freeboard, large flared bows and/or sterns such as Container/car carriers are required to provide single closed chocks, further aft than those above for tugs, or to fit recessed tug bits.	<input type="checkbox"/>
9.5	For vessels with a maximum beam of 27.73 meters or more, two additional single chocks on the stern, symmetrically spaced 3 to 6 meters from the centerline.	<input type="checkbox"/>
9.6	For vessel over 274.32 meters in length with maximum beam of 27.73 meters or more is extending to the stern: Are double chocks (SET 4) required on port and starboard, 12 to 16 m forward of the stern, 13 meters or more above the waterline at FW draft?	<input type="checkbox"/>
9.7	The single and double chocks are of a type approved for Panama Canal use.	<input type="checkbox"/>
9.7.1	Single chock -shall have a throat opening of not less than 650 square cm (100 square inches) in area, preferred dimensions are 12 x 9 inches (305 x 230 mm) and SWL 100, 000 pounds (45.36t) / 445kN.	<input type="checkbox"/>
9.7.2	Double chock -shall have a throat opening of not less than 900 square cm (140 square inches) in area, preferred dimensions are 14 x10 inches (355 x 255 mm) and SWL 140,000 pounds (64t) / 628kN.	<input type="checkbox"/>
9.8	Each single chock is accompanied by a bitt capable of withstanding a strain of 45.36t/ 445kN.	<input type="checkbox"/>
9.9	Each double chock located at the stem or stern have two pairs of heavy bitts with each bitt of each pair capable of withstanding a strain of 64t/628kN.	<input type="checkbox"/>
9.10	Other double chocks shall have a pair of accompanying heavy bitts with each bitt capable of withstanding a strain of 64t/628kN.	<input type="checkbox"/>
9.10.1	All chocks for towing wires shall be of heavy closed construction and shall have a convex bearing surface with a radius of not less than 180 mm (7 inches). The convex surface shall extend so that a wire from the bitt, or from the locks locomotive through the chock, shall be tangent to the 180 mm (7 inches) radius at any angle up to 90 degrees with respect to a straight line through the chock.	<input type="checkbox"/>
9.10.2	No part of the vessel which is in contact by the towing wires, at any angle, have a radius of less than 180 mm.	<input type="checkbox"/>
9.11	Where recessed tug bollards are installed in the hull.	<input type="checkbox"/>
9.11.1	Are the recessed hull bits not less than 3.7 meters and not more than 4.6 meters above the vessels waterline?	<input type="checkbox"/>
9.11.2	Are they installed as far forward as possible, both port and starboard sides, where the bow flare	<input type="checkbox"/>

	does not exceed 25 degrees as measured from the vertical line of the vessel's side?	
9.11.3	Vessels that have an appreciative variation in draft. Are two sets of recessed hull bitts so arranged that one bitt is located above the other?	<input type="checkbox"/>
9.12	NEO PANAMAX and PANAMAX PLUS VESSELS. For vessels with a length above 294.13m or breath above 32.31m are there:	
9.12.1	A double chock at the stem and stern? (mooring)	<input type="checkbox"/>
	Or two double chocks at the stem and stern, placed port and starboard, not more than 2.5 meters abaft the stem or 3.0 meters forward of the stern, and not more than 3.0 meters off the center line.	<input type="checkbox"/>
9.12.2	A double chock and one pair of accompanying heavy bitts, port and starboard, 2.5 to 16 meters abaft the stem (SET 1 mooring),and each bitt shall be capable of withstanding a SWL of 64 t (628 kN) in mooring operations.	<input type="checkbox"/>
9.12.3	A double chock and one pair of accompanying heavy bitts, port and starboard, 3 to 16 meters forward of the stern (SET 4 mooring),and each bitt shall be capable of withstanding a SWL of 64 t (628 kN) in mooring operations.	<input type="checkbox"/>
9.12.4	A double chock and one pair of accompanying heavy bitts (preferred diameter 500 millimeters) port and starboard 3-14 meters off centerline at the bow and stern (towing), and each bitt shall be capable of withstanding the stress caused by a SWL of 90 t (883kN).	<input type="checkbox"/>
9.12.5	A double chock and one pair of accompanying heavy bitts port and starboard 16~70 meters abaft of stem (SET2 towing), and each bitt capable of withstanding a SWL of 90 t (883kN).	<input type="checkbox"/>
9.12.6	A double chock and one pair of accompanying heavy bitts port and starboard 16~60 meters forward of stern (SET3 towing), and each bitt capable of withstanding a SWL of 90 t (883kN).	<input type="checkbox"/>
9.12.7	The rest of the chock locations for use in mooring operations shall be accompanied by one pair of heavy bitts meeting the minimum SWL of 64 t (628 kN).	<input type="checkbox"/>
9.12.8	For PANAMAX PLUS and Neo PANAMAX: Double chock -shall have a throat opening area of not less than 900 square centimeters, preferred dimension are 14 x 10 inches (355 x 255 mm) and SWL 90 t /883kN in towing operations and a minimum SWL 64t / 628kN in mooring operations from any direction.	<input type="checkbox"/>
9.12.9	Vessels with large flared bows, pronounced counters or unusually high freeboards, such as LNG carriers, container vessels, cruise vessels or vehicle carriers, will be required to provide closed chocks located further aft/forward, respectively, than those required for SET2/SET3 above for correct positioning of assisting tugs. These vessels may be required to fit recessed tug bollards into the hull in lieu of the chocks so that tugs can work without coming in contact with the flare or counter and without requiring extra-long lines and/or inefficient leads. Recessed bitts shall meet the 90 tons (883kN) SWL required above.	<input type="checkbox"/>
9.12.10	All vessels wishing to transit the new locks will be required to have mooring winches in operation and fitted with manila or synthetic mooring lines before every transit to be used during mooring operations at the new locks.	<input type="checkbox"/>
10.	Requirements for Pilot Platforms and Shelters on Certain Vessels.	
	As required by the ACP Navigation Regulations, Article 64, suitable platforms and shelters must be provided by certain vessels for assisting pilots. Control pilots will position assisting pilots where they can best contribute to vessel control, which may be at any of the existing pilot platform locations: (1) Vessels with the bridge in the extreme after part of the vessel (assisting pilot platforms will normally be forward). (2) Vessels with the bridge in the extreme forepart of the vessel (assisting pilot platforms will normally be aft).	
10.1	Platforms must afford suitable shelter to protect assisting pilots from rain and sun.	<input type="checkbox"/>
10.2	Each platform is to be erected directly over the furthest point forward of the extreme beam at the waterline and not more than six inches inboard from the outside of the vertical plane of the shell plating. For vessels where the bridge is located forward, these pilot platform shelters will be required to be erected directly over that position which is the furthest point aft of the extreme beam at the waterline and not more than six inches inboard from the outside surface of the vertical plane of the shell plating.	<input type="checkbox"/>
10.3	For all vessels whose extreme beam is 24.38 m or more: Provide bridge wing shelter platforms for the protection of control pilots at Conning Positions No. 4 and 5.	<input type="checkbox"/>
10.4	The deck of pilot platforms shall be made of wood or other material with non-skid surface,	<input type="checkbox"/>

sufficient to dry footing at all times. Overhead awning should be rigged to avoid spilling water inside the framework of the shelter during rain.

applicable and in order

outstanding recommendation

not applicable

Issued at

_____ (_____)

Issued on

Surveyor to CHINA CLASSIFICATION SOCIETY

Rev.1.0 201712

Appendix 2 Construction and Equipment Requirements for Ships Transiting the Suez Canal

1 Accommodations

1.1 A suitable (Officer Class) accommodation is to be put at the pilot's disposal.

In accordance with Art., 42(1) of the Rules of Navigation, a suitable (Officer Class) accommodation is to be put at the pilot's disposal while anchoring in the Bitter Lakes or making fast in mooring places alongside the Canal. In case of no suitable accommodation available, the vessel will pay extra dues of (1000 U.S. Dollar) for each relieving pilot.

1.2 A sheltered place is to be provided for 3-6 mooring boatmen and two shore electricians for the projector, during transit.

In accordance with Art., 42(3) of the Rules of Navigation, a sheltered place is to be provided for the mooring boatmen (3 to 6 men according to the size of the vessels) and two shore electricians for the projector, during transit. The number of mooring boatmen is determined in accordance with Art., 20 of the Rules of Navigation, e.g. 3 boatmen for vessels up to 5000 SC.G.T. and 6 boatmen for vessels over 5000 SC.G.T.

2 Mooring and anchoring

2.1 Ships must be fitted with well maintained lifting appliances capable of lifting mooring boats of 3 tons weight (including crew members).

In accordance with Art., 20(5) of the Rules of Navigation, ships must be fitted with well maintained lifting appliances capable of lifting mooring boats of 3 tons weight (including crew members). The handling of mooring boats must be carried out safely, well clear from the ship's propellers. With regard to hiring, substitution, operation and extra provision of mooring boats, reference may be made to Art., 20 of the Rules of Navigation.

2.2 Vessels must be fitted with at least 6 floating mooring ropes. For vessels equipped with tension mooring wires, the number of floating ropes may be reduced to 4. Any mooring lines likely to produce sparks are absolutely forbidden on board petroleum tankers, LPG, LNG as well as on board any vessel carrying inflammable substances.

(1) In accordance with Art., 19(1) of the Rules of Navigation, at least 6 flexible floating mooring

ropes of appropriate size for the vessel, in good condition, fitted with spliced eyes must be ready at suitable points on deck for any emergency. All arrangements must be made for their quick handling. In accordance with Art., 19(2) of the Rules of Navigation, for vessels equipped with tension mooring wires, the number of floating ropes may be reduced to 4. It is to be noted, however, that any mooring lines, likely to produce sparks by their manipulation are absolutely forbidden on board petroleum tankers, LPG, LNG as well as on board any vessel carrying inflammable substances. In addition, with regard to the requirements for manipulation of ropes and size of wires, further reference may be made to Art., 19(3) of the Rules of Navigation.

- (2) It is noted that CCS rules recommend that the number of mooring lines is not less than 4 when EN>205 and not less than 6 when EN>2530.

2.3 All vessels must be equipped with two classed anchors located forward of the collision bulkhead. Vessels of less than 1500 SC.G.T must be equipped with one working anchor located forward.

- (1) In accordance with Art., 23(1) of the Rules of Navigation, any transiting vessel must be equipped with two classed anchors located forward of the collision bulkhead. Each anchor must be fitted with its own chain or wire cable, and be capable of being released, by gravity and raised by means of a windlass or capstan. Meanwhile in accordance with Art., 23(2) of the Rules of Navigation, as an alternative, vessels of less than 1500 SC.G.T must be equipped with one working anchor located forward.
- (2) It is noted that all ships are to be provided with at least 2 bow anchors in accordance with the provisions of Section 2, Chapter 3, PART TWO of CCS Rules for Classification of Sea-going Steel Ships. As a result, ships complying with CCS rules have already complied with the requirements of the Rules of Navigation.

3 Fire fighting equipment

3.1 All vessels must have 2 fire wires.

In accordance with Art., 61(3) of the Rules of Navigation, as a precautionary measures, on approaching Canal, all vessels must have a fire wire(1) hanging over the side ready for use fore

and aft, before entering Canal. Reference may also be made to Art., 37(3) and 19(3)(c) of the Rules of Navigation.

4 Means of embarkation on and disembarkation from ships for pilots

4.1 Accommodation ladders approved by a classification society are to be provided.

In accordance with Art., 24.A (1) of the Rules of Navigation, in Anchorage Areas, outside the Canal North or South, pilot ladders can be used to embark, and disembark pilots. The ladder shall be secured in such a position that each step rests firmly against the vessel's side and so that the pilot can have safe access to the vessel. Whenever the distance from sea level to the point of access to the vessel is more than 12 feet (3.65 meters), access from the pilot ladder to the vessel shall be by means of an accommodation ladder or other equally safe and convenient means. Also in accordance with Art., 24.B(1) of the Rules of Navigation, accommodation ladders are to be used in the Canal harbours, and lakes to embark and disembark pilots.

5 Signal equipment

5.1 Availability of a red light put on aft in the Suez Canal

In accordance with Art., 92.B (13) of the Rules of Navigation, in the Canal when made fast, the 2 white lights are extinguished and a red light put on aft all the time the vessel is moored until actually underway. This requirement is significantly different from the requirements for anchor light in COLREG (IMO International Regulations for Preventing Collisions at Sea).

5.2 Vessels should be provided with signals required for transiting the canal.

Special signals used by vessels in ports and in the canal are given in Art., 92.B of the Rules of Navigation. The vessel's intent is expressed by using different combinations of lights, e.g. requiring a pilot, requiring Free Pratique, requiring a tug, no mooring boats, no searchlight, mooring etc.

A. All flags and pendants to be hoisted by vessels should be those in the International Code of Signals. Night signals shall be hoisted where best be seen by other vessels.

B. Number of signals

N0 . 1: Oil tanker carrying bulk petroleum (flash point between 73° and 150° F)

N0 . 2: Vessels carrying 1st group dangerous goods N.G.F. tankers.

LPG-LNG. Dangerous chemicals in bulk.

No . 3: Oil tanker carrying bulk petroleum (flash point under 73° F)

No . 4: Vessels carrying radioactive substances

N0 . 5: I require a pilot:

N.B. :

1. From Port to Sea or changing berth, signal to be hoisted half an hour before sailing time.
2. For the Canal at least 2 hours before the 1st Vessel is expected to enter the Canal.

N0 . 6: I require Free Pratique. (only in ports)

N0 . 7: My vessel is coming from an infected port. (only in ports)

N0 . 8: My vessel is under Quarantine.

N0 . 9: I require a tug (followed by a numeral pendant to indicate the number of tugs required).

By night : A long blast on the whistle and letters

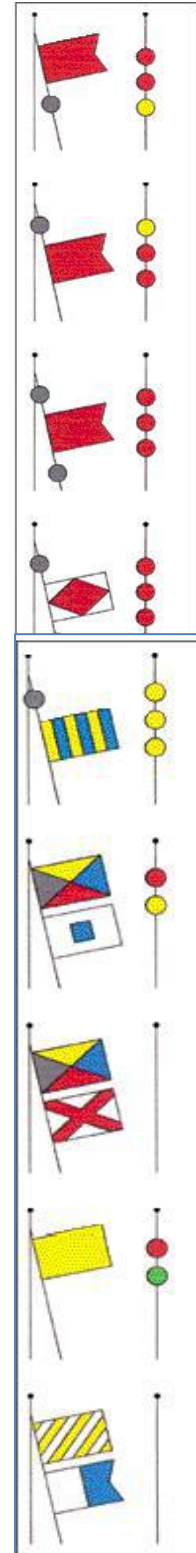

“YA ” flashed by Morse Lamp several times,
(only in port).

No . 10: I have no mooring boats. By night :
numeral 3 flashed by Morse lamp several times.
(only in port)

NO . 11: I have no shore searchlight. By night :
numeral 4 flashed by Morse lamp several times.
(only in port)

(Signals 10 & 11 can be used in one hoist if
vessel has no mooring boats and searchlight).

NO . 12: Last vessel in the convoy

NO . 13: The Vessel is making fast:

N. B. : In the Canal when made fast,
the 2 white lights are extinguished and
a red light put on aft all the time the vessel is
moored until actually underway.

NO . 13-bis: Vessels doubling in G.B.L. :

(Numeral pendant indicating new turn of vessel).

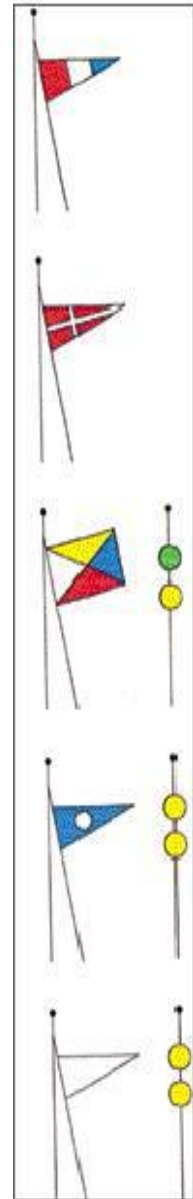

NO . 14: The vessel is manoeuvring to get underway to Sea.

NO . 15: The vessel is manoeuvring to get underway to the Canal.

No . 16: Voluntary Stopping (G. V.) “ Garage Volontaire ”.

Vessel is not ready and will not maintain her turn in the convoy.

If hoisted by a vessel in the Canal :

“ I am securely made fast and can be crossed
or doubled by other vessels in the convoy ”.

NO . 17: Aground :

“ Passage clear for tugs ”.

“ Passage not clear for tugs ”.

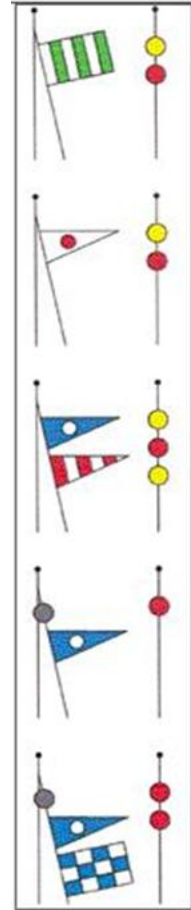

No . 18:

a) I have a Pilot on board.

b) Leaving Port Said & Port of Suez : I have a Pilot to disembark.

NO . 19: My vessel is isolated. I have no means of communication

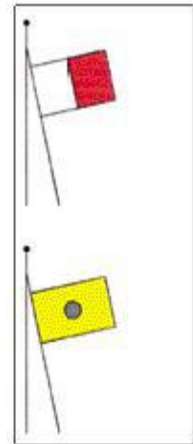

APPENDIX

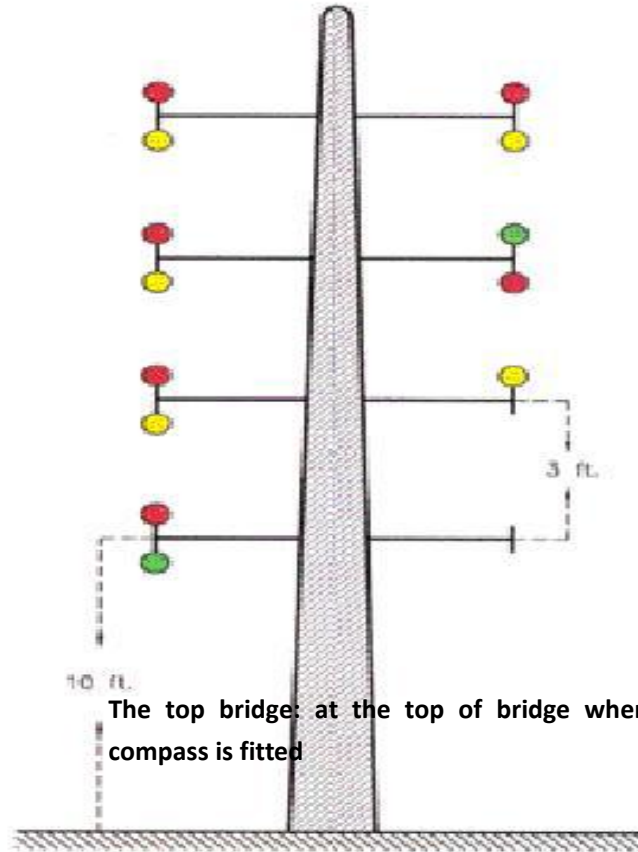

The top bridge at the top of bridge where the compass is fitted

NOTE : When made fast in the Canal, a red light in lieu of the stern light.

6 Draught Marks

All vessels shall have the draught plainly marked and painted upon the stem, amidships (including Plimsoll Mark and Deck Line) and stern post or rudder post.

In accordance with Art., 35 of the Rules of Navigation, all vessels shall have the draught plainly marked and painted upon the stem, amidships (including Plimsoll Mark and Deck Line) and stern post or rudder post according to load line convention. It is noted that SOLAS regulation II-1/5 only requires scales of draughts to be marked clearly at the bow and stern while the Rules of Navigation also requires the draught to be marked upon amidships. For the stern upon which the draught is to be marked, stern post or rudder post is defined.

7 Additional requirements for container ships

Containerships carrying different sizes of containers must have their own spreaders.

In accordance with Art., 21 of the Rules of Navigation, Containerships are advised to have their own spreaders (slings) to assist with the unloading and reloading of containers whenever necessary. However containerships carrying different sizes of containers must have their own spreaders.

8 Electrical installations

8.1 Searchlight

- (1) The vessel should be provided with a searchlight approved and certified by a classification society. The searchlight should be placed on the bow in the axis of the vessel and comply with the specifications given in Art., 28(2) of the Rules of Navigation, including range of radiation, power, material, watertightness and cooling.
- (2) Electric cables installations for searchlight and all connections leading to it must be permanently fixed, insulated and gastight. At the end of the cables, a fixed and gastight type socket should be installed close to the searchlight.
- (3) On board vessels, electrically propelled or having electrically driven gear (steering, winches, etc.) the number of generators and their individual power output must be sufficient to ensure

uninterrupted functioning of the searchlight in the event of stoppage of one of the generators.

No exception to this rule will be allowed except when there is an independent generator and circuit on board specifically set apart for the searchlight.

8.2 Overhead Lights (Deck Lights)

The vessel should be provided with overhead lights visible all round the horizon with a minimum range of 200 meters.

8.3 Bridge Wing Projectors

Bridge wing projectors on either side of the bridge must be fitted to show the Canal banks clearly during the transit and mooring operations, they must have the following characteristics: power about 4 LUX at an atmospheric transmission factor ($T = 0.74$) and minimum range 200 m.

8.4 Funnels

Funnels must be lit to facilitate the identification of the vessel by night.

**Annex Declaration of Survey Regarding Compliance with Requirements for Ship
Construction and Equipment of the Suez Canal**



Form SOC(SCA-RN) No. _____

中 国 船 级 社
CHINA CLASSIFICATION SOCIETY

**STATEMENT OF COMPLIANCE WITH THE SUEZ CANAL SHIP
ARRANGEMENT AND EQUIPMENT REQUIREMENTS**

Name of Ship	_____
Distinctive Number or Letters	_____
Port of Registry	_____
Suez Canal Gross Tonnage	_____
IMO No.	_____
CCS No.	_____
Date on which keel was laid	_____

This is to confirm that

At the request of the _____, the undersigned surveyor to this Society did attend on board the vessel at _____ on _____ for the purpose of examining the equipment and arrangements to verify compliance with the Suez Canal Rules of Navigation.

It was found that the vessel complies with the above rules according to scope of work on the enclosed survey report (Form RNc) No. _____

Note:

This statement is not issued on behalf of the Suez Canal Authority, but indicates compliance with CCS's understanding of Suez Canal Rules of Navigation. It is the prerogative of the Suez Canal Authority whether to accept this statement or to require additional evidence/ inspection of the arrangements installed.

Issued at _____	_____ (_____)
Issued on _____	Surveyor to CHINA CLASSIFICATION SOCIETY

CHINA CLASSIFICATION SOCIETY**SURVEY REPORT FORM FOR COMPLIANCE WITH REQUIRED SHIP****ARRANGEMENT AND REQUIPMENTS FOR TRANSITING THE SUEZ CANAL**

No.	Vessel Name:	CCS No.	Note
1	Can suitable accommodation (officer standard) be put at pilot's disposal?		<input type="checkbox"/>
2	Can a sheltered place be provided for 3-6 mooring-boat men?		<input type="checkbox"/>
3	And for the 2 shore electricians for the projector?		<input type="checkbox"/>
4	Lifting appliance for hoisting/lowering mooring-boats of 3 tons weight including crewmembers is provided. (Handling of boats to be carried out well clear from the propellers)		<input type="checkbox"/>
5	At least 6 floating mooring ropes are provided. The number may be reduced to 4 on ships with tension mooring wires (Synthetic ropes likely to produce sparks forbidden on oil and gas tankers)		<input type="checkbox"/>
6	One fire wire rope fore and aft for use by tugboat in case of emergency is provided.		<input type="checkbox"/>
7	An approved accommodation ladder is provided.		<input type="checkbox"/>
8	An approved searchlight with certificate stating compliance with the Suez Canal Authority Regulations is provided. (Gas tankers must have their own searchlights)		<input type="checkbox"/>
9	Electric cables and connection for the searchlight are permanently fixed, insulated and gastight.		<input type="checkbox"/>
10	At the end of cables, is a fixed and gastight socket installed close to the searchlight?		<input type="checkbox"/>
11	Is the number of generators and their individual power output sufficient to ensure uninterrupted supply to the searchlight in the event of stoppage of one of the generators?		<input type="checkbox"/>
12	Rudder angle indicator and engine rpm indicator so located and illuminated as to be easily visible by the pilot.		<input type="checkbox"/>
13	Are overhead lights (deck lights) fitted, visible all round the horizon with a		<input type="checkbox"/>

	minimum of range of 200 meters?	
14	Bridge wing projector on either side to show the canal banks clearly. Power about 4 lux and minimum 200 meters range.	<input type="checkbox"/>
15	Red Suez stern light available?	<input type="checkbox"/>
16	The vessel is equipped with the signal lights required for transit through the canal.	<input type="checkbox"/>
17	Two classed anchors located forward of the collision bulkhead fitted with own chain or wire cable, and capable of being released, and hoisted by means of a windlass. (in lieu of the above, vessels of less than 1000 SCGT must be equipped with one working anchor)	<input type="checkbox"/>
18	Lights to illuminate the funnels to facilitate the identification of the vessel by night.	<input type="checkbox"/>
Note	“×”-- Applicable and in order “O”-- Outstanding recommendation “—” Not applicable	<input type="checkbox"/>