

CCS 通 函

Circular

中国船级社
(2021 年) 通函第 4 号总第 567 号
2021 年 08 月 13 日 (共 8 页+附件)

发：有关船东及航运公司、船厂、设计单位、产品制造商、总部有关处室、研发中心、上海规范所、武汉规范所、各审图中心、各分社、本社验船师和审核员

关于现有船能效指数 (EEXI) 和营运碳强度指标 (CII) 实施要求的 通函

一、背景

为实现航运温室气体减排战略目标，国际海事组织 (IMO) 海上环境保护委员会 (MEPC) 于 2021 年 6 月召开的第 76 届会议审议通过了《MARPOL 公约》附则 VI 的修正案 (MEPC.328(76))，对国际航行的现有船舶提出了能效指数 (EEXI) 限值要求和营运碳强度指标 (CII) 评级要求。该要求将在 2023 年 1 月 1 日起实施。

EEXI 与 EEDI (新船能效设计指数) 要求类似，MEPC.328(76) 要求的 EEXI (Required EEXI) 基本等同于 2022 年 4 月 1 日生效的对新造船的 Required EEDI 要求 (EEDI Phase2 或 Phase3，视船型而定)，但对部分船型有所放宽。对于先期已满足 EEDI 要求的船舶，仍应满足 EEXI 要求，部分船舶需采用限制功率或其他技术措施提高能效才能满足 EEXI 限值要求。此外船东还需进一步深挖节能潜力，提高船舶营运能效，以满足不断提高的 CII 要求。

为帮助船公司顺利开展船舶 EEXI 与 CII 的评估、验证、评级，特制定本通函。

二、EEXI 与 CII 的公约要求

1. EEXI 要求

(1) 适用于 2023 年 1 月 1 日之前交付或重大改建的 400 总吨 (GT) 及以上属于下列类型的船舶:

散货船、液货船、集装箱船、杂货船、滚装货船、气体运输船、LNG 运输船、滚装车辆运输船、客滚船、兼用船、邮轮、冷藏货船。

(2) 每艘船舶应按 MEPC. 333(76) 要求计算“达到的 EEXI (Attained EEXI)”，并附上 EEXI 技术案卷。技术案卷应包含计算“Attained EEXI”所必要的信息并显示计算的过程。“Attained EEXI”应由本社根据 MEPC. 334(76) EEXI 验证导则进行验证。

(3) 如船舶 EEDI 已经验证，且其“Attained EEDI”小于或等于“Required EEXI”，则“Attained EEDI”可作为“Attained EEXI”。在这种情况下，“Attained EEXI”可根据 EEDI 技术案卷进行验证。

(4) 船舶应结合 2023 年 1 月 1 日之后的首次 IAPP 证书年度、中间或换证检验 (取早者) 完成 EEXI 验证，并换发 IEE 证书。适用于 EEXI 要求的重大改建船舶应在完成重大改建后，对 EEXI 要求进行验证并换发 IEE 证书。

2. CII 及 SEEMP 要求

(1) 适用于 5000 总吨及以上下列船型的船舶 (与 EEXI 适用船型相同):

散货船、液货船、集装箱船、杂货船、滚装货船、气体运输船、LNG 运输船、滚装车辆运输船、客滚船、兼用船、邮轮、冷藏货船。

(2) 以 2019 年 DCS 数据为基础制定不同船型及不同吨位船舶的“要求的年度营运 CII (Required annual operational CII)”基线，CII 年度折减系数 2023 年为 5%，2024 年为 7%，2025 年为 9%，2026 年为 11%。2023 年 1 月 1 日措施生效之前，2020 至 2022 年度“要求的年度营运 CII”可自愿实施每年降低 1%。

(3) 对于 2023 年 1 月 1 日之前交付或重大改建的船舶，应在 2023 年 1 月 1 日之前:

.1 船舶 SEEMP 应完成修订，纳入以下内容:

- ✓ 描述计算“达到的年度营运 CII (Attained annual operational CII)”的方法以及将计算值报告给主管机关的流程;
- ✓ 列出船舶未来三年 (2023-2025 年度)“要求的年度营运 CII”;

- ✓ 制定一个实施计划描述如何满足未来三年的“要求的年度营运 CII”；
- ✓ 制定一个自评估及持续改进的程序；

. 2 SEEMP 应根据 IMO 相关导则进行验证，本社确认满足要求后签发符合确认书。

(4) 对于 2023 年 1 月 1 日及以后交付或重大改建的船舶，应在船舶交付或重大改建完成时，为船舶配备符合 IMO 要求的 SEEMP 并由本社签发符合确认书。

(5) 2024 年及之后每年年初，船舶应根据 DCS 数据计算上一年度从 1 月 1 日至 12 月 31 日 12 个月期间“达到的年度营运 CII”，并在每年 3 月 31 日之前采用 IMO 标准格式通过电子方式向本社提交船舶“达到的年度营运 CII”。

(6) 如 2023 年 1 月 1 日之后发生更换船旗和/或更换公司的情况，船舶仍应在年度结束之后，计算和报告发生上述变更年度从 1 月 1 日至 12 月 31 日的完整 12 个月的“达到的年度营运 CII”。

(7) 2024 年及之后每年年初，本社对船舶提交的 DCS 报告和“达到的年度营运 CII”进行验证，根据“要求的年度营运 CII”确定船舶的营运碳强度等级并签发“燃油消耗报告和营运碳强度等级符合声明 (STATEMENT OF COMPLIANCE - FUEL OIL CONSUMPTION REPORTING AND OPERATIONAL CARBON INTENSITY RATING)”。营运碳强度等级从高到低分“A”、“B”、“C”、“D”、“E”五个等级，每年的等级“C”的中间值相当于适用于该船的“要求的年度营运 CII”。

(8) 营运碳强度评级为“E”或连续三年评级为“D”的船舶，公司应修订 SEEMP，纳入改进措施计划，描述如何通过实施改进措施计划达到“要求的年度营运 CII”。经修订的 SEEMP 最好与“达到的年度营运 CII”一起提交，最晚应不迟于每年 4 月 30 日前提提交本社进行验证，并取得本社签发的“燃油消耗报告和营运碳强度等级符合声明”。

三、公司应采取的行动

EEXI 验证/发证要求在 2023 年 1 月 1 日之后的首次 IAPP 年度、中间或换证检验时（取早者）完成。建议公司提前采取行动，确保公司所属船队顺利符合 MARPOL 公约附则 VI 修正案的相关要求。

1. 公司船队 EEXI 和 CII 的评估

为方便公司的自我评估，我社开发了“EEXI/CII 在线评估系统”（网址：<https://www.ccs-service.net/>）。公司可自行登陆我社网站，点击【EEXI/CII 在线评估系统】，根据系统要求录入相关数据。该在线评估系统会自动计算评估 EEXI 与 CII，生成评估报告，便于公司及时掌握船队现状，采取有针对性的措施。同时，公司应注意如下要求：

（1）不适用 EEDI 的船舶，公司应根据 MEPC. 333(76) 船舶“Attained EEXI” 2021 计算导则，评估是否满足 MEPC. 328(76) 规定的“Required EEXI”。

（2）适用 EEDI 要求的船舶，公司可采用 IEE 证书上的“Attained EEDI”作为“Attained EEXI”评估是否满足 MEPC. 328(76) 规定的“Required EEXI”。

（3）根据每艘船舶的 2020 年 DCS 报告数据按 MEPC. 336(76)、MEPC. 337(76)、MEPC. 338(76)、MEPC. 339(76) 要求计算“达到的年度营运 CII”和评估营运碳强度等级。如船舶营运碳强度评级出现“E”或连续三年评级为“D”的情况，公司应考虑采用何种措施改进营运能效以满足后续持续提升的 CII 要求。

2. 能效技术措施的采取

船舶“Attained EEXI”如不满足“Required EEXI”，公司可申请主机厂家或专业机构根据 MEPC. 335(76) 导则要求采取轴功率/主机功率（SHaPoLi/EPL）限制措施，准备 SHaPoLi/EPL 技术文件和用于 SHaPoLi/EPL 的船上管理手册(OMM) 以符合 EEXI 要求。采用该技术措施应满足如下要求：

（1）轴功率/主机功率限制系统应满足 MEPC. 335(76) 规定的技术要求。系统的符合性应根据 MEPC. 335(76) 要求通过我社检验确认。

（2）公司应按 MEPC. 335(76) 要求制定 OMM 管理手册，在 Attained EEXI 验证完成后提交本社进行确认。该管理手册应永久保存在船；

（3）当船舶采用轴功率/主机功率限制系统，若 NO_x 关键设置和/或部件的改变超出批准的主机 NO_x 技术案卷的允许，则主机应重新认证。

公司可采取其他的能效技术措施来提升船舶的能效水平，并向我社咨询 EEXI 评估和验证事宜。

3. EEXI 技术案卷的准备

（1）对于 EEDI 适用的船舶，当船舶“Attained EEDI”满足“Required EEXI”

要求,船舶的 EEDI 技术案卷可接受作为 EEXI 技术案卷;当船舶“Attained EEDI”不满足“Required EEXI”要求,则应该按《MEPC. 334(76)-EEXI 检验和发证 2021 导则》的要求准备 EEXI 技术案卷,包括:

- ① EEDI 技术案卷;
- ② 能效技术措施描述及计算和验证所需材料(如有);
- ③ 所得 EEXI 的计算值,包括计算总结,至少包含用以得出 EEXI 的计算参数和计算过程的每一个取值;
- ④ LNG 船 EEXI 计算所需的补充信息。

(2)对于 EEDI 不适用的船舶,应该按《MEPC. 334(76)-EEXI 检验和发证 2021 导则》的要求准备 EEXI 技术案卷,包括:

- ① 载重吨或者总吨(对客滚船和非传统推进的豪华邮轮);
- ② 主机和辅机的额定功率(MCR);
- ③ 主机安装轴功率/主机功率限定系统后的限定功率(MCRlim);
- ④ 通过估算方法、速度功率曲线、试航结果等获得的 EEXI 航速及其证明文件;
- ⑤ 燃油类型;
- ⑥ EEXI 计算所需的主机和辅机的燃油消耗量(SFC);
- ⑦ 辅机功率 PAE 及其计算支持文件;
- ⑧ 主尺度,船舶类型和用以界定船舶类型、入级符号和船上的推进系统及供电系统的相关信息;
- ⑨ 所得 EEXI 的计算值,包括计算总结,至少包含用以得出 EEXI 的计算参数和计算过程的每一个取值;
- ⑩ LNG 船 EEXI 计算所需的补充信息;
- ⑪ 节能装置相关描述及试验报告(如有)。

4. EEXI 验证的申请

公司应在 2023 年 1 月 1 日之后的船舶首次 IAPP 年度、中间或换证检验(取早者)之前完成 EEXI 验证,向我社申请换发 IEE 证书。公司为满足 EEXI 所采取的能效技术措施应尽早实施并申请本社检验确认。对于轴功率/主机功率限制系

统的检验确认，在 EEXI 技术案卷批准后再安排。

5. 船舶能效管理计划 SEEMP 的修改编制

公司应在 2023 年 1 月 1 日之前完成船舶能效管理计划 SEEMP 的修订并提交本社审批，取得我社签发的符合确认书。

四、我社提供的服务

1. EEXI 及 CII 的技术评估与咨询服务

1) 技术评估服务

我社可结合已积累的 EEXI/CII 评估及计算的实践经验，为船东提供如下涉及 EEXI/CII 计算、评估和预验证的技术评估服务：

- (1) EEXI 计算、评估和预验证；
- (2) CII 计算、评级和预验证；
- (3) 提高船舶 EEXI 与 CII 的技术措施的评估、预验证，包括：
 - ✓ 非 EEDI 船舶航速与功率（水池、数字计算等）评估、预验证；
 - ✓ 节能装置（动力系统及水动力系统等）效果评估、预验证；
 - ✓ 降功率方案设计与效果评估及 SHaPoLi/EPL 船上管理手册编制。
- (4) EEXI 技术案卷的编制。

2) 技术咨询服务

为方便公司了解熟悉相关的公约要求，本社提供船舶 EEXI/CII 相关的技术咨询，包括以下方面：

- (1) 船舶 EEXI/CII 技术要求；
- (2) 船舶 EEXI/CII 计算方案；
- (3) EEXI/CII 对单船和船队的影响分析；
- (4) 改进船舶 EEXI/CII 的措施分析。

2. 我社入级船舶的 EEXI 技术案卷验证、发证

公司应将船舶 EEXI 验证申请、EEXI 技术案卷（至少有英文版本）及相关背景资料向公司所在地分社提交申请，由分社协调安排船舶审图部门进行批准。我社将在 2023 年 1 月 1 日之后的首次 IAPP 年度、中间或换证检验（取早者），完成我社入级船舶的 IEE 证书换发工作，其中：

(1) 采用限制轴功率/主机功率措施以满足 EEXI 要求的船舶，还应提供主机厂家或专业机构出具的轴功率/主机功率限制 (SHaPoLi/EPL) 技术文件以及 SHaPoLi/EPL 船上管理手册。待我社完成 EEXI 技术案卷验证和船上管理手册审批后，公司再申请 SHaPoLi/EPL 系统现场验证，该验证可结合 2023 年 1 月 1 日之后 IEE 证书的换发同时进行确认。

(2) 适用 EEDI 且 “Attained EEDI” 直接满足 “Required EEXI” 要求的船舶，公司所在地 CCS 辖区分社完成 EEDI 技术案卷验证后将直接为船舶换发 IEE 证书；公司也可结合 2023 年 1 月 1 日之后的首次 IAPP 年度、中间或换证检验(取早者) 向我社检验单位申请换发 IEE 证书。

(3) 我社可应公司申请在 2023 年 1 月 1 日之前为船舶签发 EEXI 符合声明。

3. CII 验证及发证

我社将为持有我社签发的燃油消耗符合声明船舶(含非我社入级的船舶) 开展 CII 验证并签发符合声明：

(1) 2024 年及之后每年 3 月 31 日之前，公司应将 “达到的年度营运 CII” 的 DCS 报告和 DCS 验证所需的相关材料提交公司所在地的分社；

(2) 公司可先自行对船舶营运碳强度进行评级，如评级为 “E” 或连续三年评级为 “D”，公司应修订 SEEMP，纳入 CII 改进措施计划，随同 DCS 报告一起提交 CCS。经修订的 SEEMP 最晚不迟于 4 月 30 日之前提交我社进行验证；

(3) 根据 IMO 相关决议 (还未发布)，在某些特殊情况下的燃油消耗和航程里程可从 CII 计算和评级中扣除。公司如申请扣除，应提供报告和相关的证明材料。

(4) 我社在完成 DCS 验证以及船舶营运碳强度评级和 SEEMP 修改审批 (如适用) 后，将在 5 月 31 日之前为船舶签发 “燃油消耗报告和营运碳强度等级符合声明”。

(5) 在 2024 年之前，CCS 根据客户需求，也可为船舶签发自愿性的 “营运碳强度等级符合声明”。

五、我社服务的联系方式

1. EEXI、CII 的技术评估与咨询服务

(1) 技术服务邮箱: GHG@ccs.org.cn

(2) 联系方式:

联系电话: 010-58112347 邮箱: cqzhang@ccs.org.cn

联系电话: 010-58112065 邮箱: ygsun@ccs.org.cn

2. EEXI、CII 技术案卷审批、验证及其他事宜, 请直接与公司所在地分社船舶客户经理联系。

本通函在本社网站(www.ccs.org.cn) 上发布, 并附上 IMO 相关文件的英文版。

附件:

1. MEPC. 333(76)-2021 GUIDELINES ON THE METHOD OF CALCULATION OF THE ATTAINED ENERGY EFFICIENCY EXISTING SHIP INDEX (EEXI)
2. MEPC. 334(76)-2021 GUIDELINES ON SURVEY AND CERTIFICATION OF THE ATTAINED ENERGY EFFICIENCY EXISTING SHIP INDEX (EEXI)
3. MEPC. 335(76)- 2021 GUIDELINES ON THE SHAFT / ENGINE POWER LIMITATION SYSTEM TO COMPLY WITH THE EEXI REQUIREMENTS AND USE OF A POWER RESERVE
4. MEPC. 336(76)-2021 GUIDELINES ON OPERATIONAL CARBON INTENSITY INDICATORS AND THE CALCULATION METHODS (CII GUIDELINES, G1)
5. MEPC. 337 (76) -2021 GUIDELINES ON THE REFERENCE LINES FOR USE WITH OPERATIONAL CARBON INTENSITY INDICATORS (CII REFERENCE LINES GUIDELINES, G2)
6. MEPC. 338(76)-2021 GUIDELINES ON THE OPERATIONAL CARBON INTENSITY REDUCTION FACTORS RELATIVE TO REFERENCE LINES (CII REDUCTION FACTORS GUIDELINES, G3)
7. MEPC. 339(76)-GUIDELINES ON THE OPERATIONAL CARBON INTENSITY RATING OF SHIPS (CII RATING GUIDELINES, G4)

ANNEX 7

**RESOLUTION MEPC.333(76)
(adopted on 17 June 2021)**

**2021 GUIDELINES ON THE METHOD OF CALCULATION OF THE ATTAINED
ENERGY EFFICIENCY EXISTING SHIP INDEX (EEXI)**

THE MARINE ENVIRONMENT PROTECTION COMMITTEE,

RECALLING Article 38(a) of the Convention on the International Maritime Organization concerning the functions of the Marine Environment Protection Committee conferred upon it by international conventions for the prevention and control of marine pollution from ships,

NOTING that it adopted, by resolution MEPC.328(76), the 2021 revised MARPOL Annex VI, which is expected to enter into force on 1 November 2022 upon its deemed acceptance on 1 May 2022,

NOTING IN PARTICULAR that the 2021 revised MARPOL Annex VI contains amendments concerning mandatory goal-based technical and operational measures to reduce carbon intensity of international shipping,

NOTING FURTHER that regulation 23 of MARPOL Annex VI requires that the attained EEXI shall be calculated taking into account the guidelines developed by the Organization,

RECOGNIZING that the aforementioned amendments to MARPOL Annex VI require relevant guidelines for uniform and effective implementation of the regulations and to provide sufficient lead time for industry to prepare,

HAVING CONSIDERED, at its seventy-sixth session, draft *2021 Guidelines on the method of calculation of the attained Energy Efficiency Existing Ship Index (EEXI)*,

1 ADOPTS the *2021 Guidelines on the method of calculation of the attained Energy Efficiency Existing Ship Index (EEXI)*, as set out in the annex to the present resolution;

2 INVITES Administrations to take the annexed Guidelines into account when developing and enacting national laws which give force to and implement requirements set forth in regulation 23 of MARPOL Annex VI;

3 REQUESTS the Parties to MARPOL Annex VI and other Member Governments to bring the annexed Guidelines to the attention of masters, seafarers, shipowners, ship operators and any other interested parties;

4 AGREES to keep the Guidelines under review in light of experience gained with their implementation and in light of the review of EEXI regulations to be completed by the Organization by 1 January 2026 as identified in regulation 25.3 of MARPOL Annex VI.

ANNEX

2021 GUIDELINES ON THE METHOD OF CALCULATION OF THE ATTAINED ENERGY EFFICIENCY EXISTING SHIP INDEX (EEXI)

CONTENTS

- 1 Definitions
- 2 Energy Efficiency Existing Ship Index (EEXI)
 - 2.1 EEXI formula
 - 2.2 Parameters
 - 2.2.1 $P_{ME(i)}$; Power of main engines
 - 2.2.2 $P_{AE(i)}$; Power of auxiliary engines
 - 2.2.3 V_{ref} ; Ship speed
 - 2.2.4 SFC ; Certified specific fuel consumption
 - 2.2.5 C_F ; Conversion factor between fuel consumption and CO₂ emission
 - 2.2.6 Correction factor for ro-ro cargo and ro-ro passenger ships (f_{jRoRo})
 - 2.2.7 Correction factor for ro-ro cargo ships (vehicle carrier) ($f_{cVEHICLE}$)
- APPENDIX Parameters to calculate $V_{ref,app}$

1 Definitions

1.1 *MARPOL* means the International Convention for the Prevention of Pollution from Ships, 1973, as modified by the Protocols of 1978 and 1997 relating thereto, as amended.

1.2 For the purpose of these Guidelines, the definitions in *MARPOL* Annex VI, as amended, apply.

2 Energy Efficiency Existing Ship Index (EEXI)

2.1 EEXI formula

The attained Energy Efficiency Existing Ship Index (EEXI) is a measure of ship's energy efficiency (g/t*nm) and calculated by the following formula:

$$\frac{\left(\prod_{j=1}^n f_j \right) \left(\sum_{i=1}^{nME} P_{ME(i)} \cdot C_{FME(i)} \cdot SFC_{ME(i)} \right) + (P_{AE} \cdot C_{FAE} \cdot SFC_{AE}^*) + \left(\prod_{j=1}^n f_j \cdot \sum_{i=1}^{nPTI} P_{PTI(i)} - \sum_{i=1}^{neff} f_{eff(i)} \cdot P_{AEff(i)} \right) C_{FAE} \cdot SFC_{AE} - \left(\sum_{i=1}^{neff} f_{eff(i)} \cdot P_{eff(i)} \cdot C_{FME} \cdot SFC_{ME}^{**} \right)}{f_i \cdot f_c \cdot f_i \cdot Capacity \cdot f_w \cdot V_{ref} \cdot f_m}$$

* If part of the Normal Maximum Sea Load is provided by shaft generators, SFC_{ME} and C_{FME} may – for that part of the power – be used instead of SFC_{AE} and C_{FAE}

** In case of $P_{PTI(i)} > 0$, the average weighted value of $(SFC_{ME} \cdot C_{FME})$ and $(SFC_{AE} \cdot C_{FAE})$ to be used for calculation of P_{eff}

Note: This formula may not be applicable to a ship having diesel-electric propulsion, turbine propulsion or hybrid propulsion system, except for cruise passenger ships and LNG carriers.

Ships falling into the scope of EEDI requirement can use their attained EEDI calculated in accordance with the *2018 Guidelines on the method of calculation of the attained EEDI for new ships* (resolution MEPC.308(73), as amended, the "EEDI Calculation Guidelines" hereafter) as the attained EEXI if the value of the attained EEDI is equal to or less than that of the required EEXI.

2.2 Parameters

For calculation of the attained EEXI by the formula in paragraph 2.1, parameters under the EEDI Calculation Guidelines apply, unless expressly provided otherwise. In referring to the aforementioned guidelines, the terminology "EEDI" should be read as "EEXI".

2.2.1 $P_{ME(i)}$; Power of main engines

In cases where overridable Shaft / Engine Power Limitation is installed in accordance with the *2021 Guidelines on the shaft / engine power limit to comply with the EEXI requirements and use of a power reserve* (resolution MEPC.335(76)), $P_{ME(i)}$ is 83% of the limited installed power (MCR_{lim}) or 75% of the original installed power (MCR), whichever is lower, for each main engine (i). In cases where the overridable Shaft / Engine Power Limitation and shaft generator(s) are installed, in referring to paragraph 2.2.5.2 (option 1) of the EEDI Calculation Guidelines, " MCR_{ME} " should be read as " MCR_{lim} ".

For LNG carriers having steam turbine or diesel electric propulsion, $P_{ME(i)}$ is 83% of the limited installed power (MCR_{lim} , MPP_{lim}), divided by the electrical efficiency in case of diesel electric propulsion system, for each main engine (i). For LNG carriers, the power from combustion of

the excessive natural boil-off gas in the engines or boilers to avoid releasing to the atmosphere or unnecessary thermal oxidation should be deducted from $P_{ME(i)}$ with the approval of the verifier.

2.2.2 $P_{AE(i)}$; Power of auxiliary engines

2.2.2.1 $P_{AE(i)}$ is calculated in accordance with paragraph 2.2.5.6 of the EEDI Calculation Guidelines.

2.2.2.2 For ships where power of auxiliary engines (P_{AE}) value calculated by paragraphs 2.2.5.6.1 to 2.2.5.6.3 of the EEDI Calculation Guidelines is significantly different from the total power used at normal seagoing, e.g. in cases of passenger ships, the P_{AE} value should be estimated by the consumed electric power (excluding propulsion) in conditions when the ship is engaged in a voyage at reference speed (V_{ref}) as given in the electric power table, divided by the average efficiency of the generator(s) weighted by power (see appendix 2 of the EEDI Calculation Guidelines).

2.2.2.3 In cases where the electric power table is not available, the P_{AE} value may be approximated either by:

- .1 annual average figure of P_{AE} at sea from onboard monitoring obtained prior to the EEXI certification;
- .2 for cruise passenger ships, approximated value of power of auxiliary engines ($P_{AE,app}$), as defined below:

$$P_{AE,app} = 0.1193 \times GT + 1814.4 \quad [\text{kW}]$$

- .3 for ro-ro passenger ships, approximated value of power of auxiliary engines ($P_{AE,app}$), as defined below:

$$P_{AE,app} = 0.866 \times GT^{0.732} \quad [\text{kW}]$$

2.2.3 V_{ref} ; Ship speed

2.2.3.1 For ships falling into the scope of the EEDI requirement, the ship speed V_{ref} should be obtained from an approved speed-power curve as defined in the *2014 Guidelines on survey and certification of the Energy Efficiency Design Index (EEDI)*, as amended (resolution MEPC.254(67), as amended).

2.2.3.2 For ships not falling into the scope of the EEDI requirement, the ship speed V_{ref} should be obtained from an estimated speed-power curve as defined in the *2021 Guidelines on survey and certification of the attained EEXI* (resolution MEPC.334(76)).

2.2.3.3 For ships not falling into the scope of the EEDI requirement but whose sea trial results, which may have been calibrated by the tank test, under the EEDI draught and the sea condition as specified in paragraph 2.2.2 of the EEDI Calculation Guidelines are included in the sea trial report, the ship speed V_{ref} may be obtained from the sea trial report:

$$V_{ref} = V_{S,EEDI} \times \left[\frac{P_{ME}}{P_{S,EEDI}} \right]^{\frac{1}{3}} \quad [\text{knot}]$$

where,

$V_{S,EEDI}$, is the sea trial service speed under the EEDI draught; and

$P_{S,EEDI}$ is power of the main engine corresponding to $V_{S,EEDI}$.

2.2.3.4 For containerships, bulk carriers or tankers not falling into the scope of the EEDI requirement but whose sea trial results, which may have been calibrated by the tank test, under the design load draught and sea condition as specified in paragraph 2.2.2 of the EEDI Calculation Guidelines are included in the sea trial report, the ship speed V_{ref} may be obtained from the sea trial report:

$$V_{ref} = k^{\frac{1}{3}} \times \left(\frac{DWT_{S,service}}{Capacity} \right)^{\frac{2}{9}} \times V_{S,service} \times \left[\frac{P_{ME}}{P_{S,service}} \right]^{\frac{1}{3}} \quad [\text{knot}]$$

where,

$V_{S,service}$ is the sea trial service speed under the design load draught;

$DWT_{S,service}$ is the deadweight under the design load draught;

$P_{S,service}$ is the power of the main engine corresponding to $V_{S,service}$;

k is the scale coefficient, which should be:

- .1 0.95 for containerships with 120,000 DWT or less;
- .2 0.93 for containerships with more than 120,000 DWT;
- .3 0.97 for bulk carrier with 200,000 DWT or less;
- .4 1.00 for bulk carrier with more than 200,000 DWT;
- .5 0.97 for tanker with 100,000 DWT or less; and
- .6 1.00 for tanker with more than 100,000 DWT.

2.2.3.5 In cases where the speed-power curve is not available or the sea trial report does not contain the EEDI or design load draught condition, the ship speed V_{ref} can be approximated by $V_{ref,app}$ to be obtained from statistical mean of distribution of ship speed and engine power, as defined below:

$$V_{ref,app} = (V_{ref,avg} - m_V) \times \left[\frac{\sum P_{ME}}{0.75 \times MCR_{avg}} \right]^{\frac{1}{3}} \quad [\text{knot}]$$

For LNG carriers having diesel electric propulsion system and cruise passenger ship having non-conventional propulsion,

$$V_{ref,app} = (V_{ref,avg} - m_V) \times \left[\frac{\sum MPP_{Motor}}{MPP_{avg}} \right]^{\frac{1}{3}} \quad [\text{knot}]$$

where,

$V_{ref,avg}$ is a statistical mean of distribution of ship speed in given ship type and ship size, to be calculated as follows:

$$V_{ref,avg} = A \times B^C$$

where

A, B and C are the parameters given in the appendix;

m_V is a performance margin of a ship, which should be 5% of $V_{ref,avg}$ or one knot, whichever is lower; and

MCR_{avg} is a statistical mean of distribution of MCRs for main engines and MPP_{avg} is a statistical mean of distribution of MPPs for motors in given ship type and ship size, to be calculated as follows:

$$MCR_{avg} \text{ or } MPP_{avg} = D \times E^F$$

where

D, E and F are the parameters given in the appendix;

In cases where the overridable Shaft / Engine Power Limitation is installed, the ship speed V_{ref} approximated by $V_{ref,app}$ should be calculated as follows:

$$V_{ref,app} = (V_{ref,avg} - m_V) \times \left[\frac{\sum P_{ME}}{0.75 \times MCR_{avg}} \right]^{\frac{1}{3}} \quad [\text{knot}]$$

For LNG carriers having diesel electric propulsion system and cruise passenger ship having non-conventional propulsion, the ship speed V_{ref} approximated by $V_{ref,app}$ should be calculated as follows:

$$V_{ref,app} = (V_{ref,avg} - m_V) \times \left[\frac{\sum MPP_{lim}}{MPP_{avg}} \right]^{\frac{1}{3}}$$

2.2.3.6 Notwithstanding the above, in cases where the energy saving device* is installed, the effect of the device may be reflected in the ship speed V_{ref} with the approval of the verifier, based on the following methods in accordance with defined quality and technical standards:

- .1 sea trials after installation of the device; and/or
- .2 dedicated model tests; and/or
- .3 numerical calculations.

* Devices that shift the power curve, which results in the change of P_P and V_{ref} , as specified in MEPC.1/Circ.815 on 2013 Guidance on treatment of innovative energy efficiency technologies for calculation and verification of the attained EEDI.

2.2.4 SFC; Certified specific fuel consumption

In cases where overridable Shaft / Engine Power Limitation is installed, the *SFC* corresponding to the P_{ME} should be interpolated by using *SFCs* listed in an applicable test report included in an approved NO_x Technical File of the main engine as defined in paragraph 1.3.15 of the NO_x Technical Code.

Notwithstanding the above, the *SFC* specified by the manufacturer or confirmed by the verifier may be used.

For those engines which do not have a test report included in the NO_x Technical File and which do not have the *SFC* specified by the manufacturer or confirmed by the verifier, the *SFC* can be approximated by SFC_{app} defined as follows:

$$SFC_{ME,app} = 190 [g/kWh]$$

$$SFC_{AE,app} = 215 [g/kWh]$$

2.2.5 C_F; Conversion factor between fuel consumption and CO₂ emission

For those engines which do not have a test report included in the NO_x Technical File and which do not have the *SFC* specified by the manufacturer, the C_F corresponding to SFC_{app} should be defined as follows:

$$C_F = 3.114 [t \cdot CO_2/t \cdot Fuel] \text{ for diesel ships (incl. HFO use in practice)}$$

Otherwise, paragraph 2.2.1 of the EEDI Calculation Guidelines applies.

2.2.6 Correction factor for ro-ro cargo and ro-ro passenger ships (f_{jRoRo})

For ro-ro cargo and ro-ro passenger ships, f_{jRoRo} is calculated as follows:

$$f_{jRoRo} = \frac{1}{F_{nL}^\alpha \cdot \left(\frac{L_{pp}}{B_S}\right)^\beta \cdot \left(\frac{B_S}{d_S}\right)^\gamma \cdot \left(\frac{L_{pp}}{V^{1/3}}\right)^\delta} \quad ; \text{ if } f_{jRoRo} > 1 \text{ then } f_j = 1$$

where the Froude number, F_{nL} , is defined as:

$$F_{nL} = \frac{0.5144 \cdot V_{ref,F}}{\sqrt{L_{pp} \cdot g}}$$

where $V_{ref,F}$ is the ship design speed corresponding to 75% of MCR_{ME} :

and the exponents α , β , γ and δ are defined as follows:

Ship type	Exponent:			
	α	β	γ	δ
Ro-ro cargo ship	2.00	0.50	0.75	1.00
Ro-ro passenger ship	2.50	0.75	0.75	1.00

2.2.7 Cubic capacity correction factor for ro-ro cargo ships (vehicle carrier) ($f_{cVEHICLE}$)

For ro-ro cargo ships (vehicle carrier) having a DWT/GT ratio of less than 0.35, the following cubic capacity correction factor, $f_{cVEHICLE}$, should apply:

$$f_{cVEHICLE} = \left(\frac{(DWT/GT)}{0.35} \right)^{-0,8}$$

Where DWT is the capacity and GT is the gross tonnage in accordance with the International Convention of Tonnage Measurement of Ships 1969, annex I, regulation 3.

APPENDIX

Parameters to calculate $V_{ref,avg}$

Ship type	A	B	C
Bulk carrier	10.6585	DWT of the ship	0.02706
Gas carrier	7.4462	DWT of the ship	0.07604
Tanker	8.1358	DWT of the ship	0.05383
Containership	3.2395	DWT of the ship where DWT ≤ 80,000 80,000 where DWT > 80,000	0.18294
General cargo ship	2.4538	DWT of the ship	0.18832
Refrigerated cargo carrier	1.0600	DWT of the ship	0.31518
Combination carrier	8.1391	DWT of the ship	0.05378
LNG carrier	11.0536	DWT of the ship	0.05030
Ro-ro cargo ship (vehicle carrier)	16.6773	DWT of the ship	0.01802
Ro-ro cargo ship	8.0793	DWT of the ship	0.09123
Ro-ro passenger ship	4.1140	DWT of the ship	0.19863
Cruise passenger ship having non-conventional propulsion	5.1240	GT of the ship	0.12714

Parameters to calculate MCR_{avg} or MPP_{avg} (= D x E^F)

Ship type	D	E	F
Bulk carrier	23.7510	DWT of the ship	0.54087
Gas carrier	21.4704	DWT of the ship	0.59522
Tanker	22.8415	DWT of the ship	0.55826
Containership	0.5042	DWT of the ship where DWT ≤ 95,000 95,000 where DWT > 95,000	1.03046
General cargo ship	0.8816	DWT of the ship	0.92050
Refrigerated cargo carrier	0.0272	DWT of the ship	1.38634
Combination carrier	22.8536	DWT of the ship	0.55820
LNG carrier	20.7096	DWT of the ship	0.63477
Ro-ro cargo ship (vehicle carrier)	262.7693	DWT of the ship	0.39973
Ro-ro cargo ship	37.7708	DWT of the ship	0.63450
Ro-ro passenger ship	9.1338	DWT of the ship	0.91116
Cruise passenger ship having non-conventional propulsion	1.3550	GT of the ship	0.88664

Calculation of parameters to calculate $V_{ref,avg}$ and MCR_{avg}

Data sources

1 IHS Fairplay (IHSF) database with the following conditions are used.

Ship type	Ship size	Delivered period	Type of propulsion systems	Population
Bulk carrier	≥ 10,000 DWT	From 1 January 1999 to 1 January 2009	Conventional	2,433
Gas carrier	≥ 2,000 DWT		Conventional	292
Tanker	≥ 4,000 DWT		Conventional	3,345
Containership	≥ 10,000 DWT		Conventional	2,185
General cargo ship	≥ 3,000 DWT		Conventional	1,673
Refrigerated cargo carrier	≥ 3,000 DWT		Conventional	53
Combination carrier	≥ 4,000 DWT		Conventional	3,351
LNG carrier	≥ 10,000 DWT		Conventional, Non-conventional	185
Ro-ro cargo ship (vehicle carrier)	≥ 10,000 DWT		Conventional	301
Ro-ro cargo ship	≥ 1,000 DWT		From 1 January 1998 to 31 December 2010	Conventional
Ro-ro passenger ship	≥ 250 DWT	Conventional		350
Cruise passenger ship having non-conventional propulsion	≥ 25,000 GT	From 1 January 1999 to 1 January 2009	Non-conventional	93

2 Data sets with blank/zero "Service speed", "Capacity" and/or Total kW of M/E" are removed.

3 Ship type is in accordance with table 1 and table 2 of resolution MEPC.231(65) on 2013 Guidelines for calculation of reference lines for use with the Energy Efficiency Design Index (EEDI). However, "Gas carrier" does not include "LNG carrier". Parameters for "LNG carrier" are given separately.

ANNEX 8

**RESOLUTION MEPC.334(76)
(adopted on 17 June 2021)**

**2021 GUIDELINES ON SURVEY AND CERTIFICATION OF THE ATTAINED ENERGY
EFFICIENCY EXISTING SHIP INDEX (EEXI)**

THE MARINE ENVIRONMENT PROTECTION COMMITTEE,

RECALLING Article 38(a) of the Convention on the International Maritime Organization concerning the functions of the Marine Environment Protection Committee conferred upon it by international conventions for the prevention and control of marine pollution from ships,

NOTING that it adopted, by resolution MEPC.328(76), the 2021 revised MARPOL Annex VI, which is expected to enter into force on 1 November 2022 upon its deemed acceptance on 1 May 2022,

NOTING IN PARTICULAR that the 2021 revised MARPOL Annex VI contains amendments concerning mandatory goal-based technical and operational measures to reduce carbon intensity of international shipping,

NOTING FURTHER that regulation 5 (Surveys) of MARPOL Annex VI, as amended, requires that ships to which chapter 4 applies shall also be subject to survey and certification taking into account guidelines developed by the Organization,

RECOGNIZING that the aforementioned amendments to MARPOL Annex VI require relevant guidelines for uniform and effective implementation of the regulations and to provide sufficient lead time for industry to prepare,

HAVING CONSIDERED, at its seventy-sixth session, draft *2021 Guidelines on survey and certification of the Energy Efficiency Existing Ship Index (EEXI)*,

1 ADOPTS the *2021 Guidelines on survey and certification of the Energy Efficiency Existing Ship Index (EEXI)*, as set out in the annex to the present resolution;

2 INVITES Administrations to take the annexed Guidelines into account when developing and enacting national laws which give force to and implement requirements set forth in regulation 5 of MARPOL Annex VI;

3 REQUESTS the Parties to MARPOL Annex VI and other Member Governments to bring the annexed Guidelines to the attention of masters, seafarers, shipowners, ship operators and any other interested parties;

4 AGREES to keep the Guidelines under review in light of experience gained with their implementation and in light of the review of EEXI regulations to be completed by the Organization by 1 January 2026 as identified in regulation 25.3 of MARPOL Annex VI.

ANNEX

**2021 GUIDELINES ON SURVEY AND CERTIFICATION OF THE ATTAINED ENERGY
EFFICIENCY EXISTING SHIP INDEX (EEXI)**

Table of contents

1	GENERAL
2	DEFINITIONS
3	APPLICATION
4	PROCEDURES FOR SURVEY AND CERTIFICATION
4.1	General
4.2	Verification of the attained EEXI
4.3	Verification of the attained EEXI in case of major conversion
APPENDIX	Sample of EEXI Technical File

1 GENERAL

The purpose of these guidelines is to assist verifiers of the Energy Efficiency Existing Ship Index (EEXI) of ships in conducting the survey and certification of the EEXI, in accordance with regulations 5, 6, 7, 8 and 9 of MARPOL Annex VI, and assist shipowners, shipbuilders, manufacturers and other interested parties in understanding the procedures for the survey and certification of the EEXI.

2 DEFINITIONS¹

2.1 *Verifier* means an Administration, or organization duly authorized by it, which conducts the survey and certification of the EEXI in accordance with regulations 5, 6, 7, 8 and 9 of MARPOL Annex VI and these Guidelines.

2.2 *Ship of the same type* means a ship the hull form (expressed in the lines such as sheer plan and body plan), excluding additional hull features such as fins, and principal particulars of which are identical to that of the base ship.

2.3 *Tank test* means model towing tests, model self-propulsion tests and model propeller open water tests. Numerical calculations may be accepted as equivalent to model propeller open water tests or used to complement the tank tests conducted (e.g. to evaluate the effect of additional hull features such as fins, etc. on ships' performance), or as a replacement for model tests provided that the methodology and numerical model used have been validated/calibrated against parent hull sea trials and/or model tests, with the approval of the verifier.

2.4 *MARPOL* means the International Convention for the Prevention of Pollution from Ships, 1973, as modified by the Protocols of 1978 and 1997 relating thereto, as amended.

2.5 For the purpose of these Guidelines, the definitions in MARPOL Annex VI, as amended, apply.

3 APPLICATION

These Guidelines should be applied to ships for which an application for a survey for verification of the ship's EEXI specified in regulation 5 of MARPOL Annex VI has been submitted to a verifier.

4 PROCEDURES FOR SURVEY AND CERTIFICATION

4.1 General

4.1.1 The attained EEXI should be calculated in accordance with regulation 23 of MARPOL Annex VI and the *2021 Guidelines on the method of calculation of the attained Energy Efficiency Existing Ship Index (EEXI)* (resolution MEPC.333(76)) (EEXI Calculation Guidelines).

4.1.2 The 2013 Guidance on treatment of innovative energy efficiency technologies for calculation and verification of the attained EEDI (MEPC.1/Circ.815) should be applied for calculation of the attained EEXI, if applicable.

¹ Other terms used in these Guidelines have the same meaning as those defined in the *2018 Guidelines on the method of calculation of the attained EEDI for new ships* (resolution MEPC.308(73), as amended) and the *2021 Guidelines on the method of calculation of the attained EEXI* (resolution MEPC.333(76)).

4.1.3 The information used in the verification process may contain confidential information of submitters, including shipyards, which requires Intellectual Property Rights (IPR) protection. In the case where the submitter wants a non-disclosure agreement with the verifier, the additional information should be provided to the verifier upon mutually agreed terms and conditions.

4.2 Verification of the attained EEXI

4.2.1 For verification of the attained EEXI, an application for a survey and an EEXI Technical File containing the necessary information for the verification and other relevant background documents should be submitted to a verifier, unless the attained EEDI of the ship satisfies the required EEXI.

4.2.2 The EEXI Technical File should be written at least in English. The EEXI Technical File should include, but not be limited to:

- .1 deadweight (DWT) or gross tonnage (GT) for ro-ro passenger ship and cruise passenger ship having non-conventional propulsion;
- .2 the rated installed power (MCR) of the main and auxiliary engines;
- .3 the limited installed power (MCR_{lim}) in cases where the overridable Shaft / Engine Power Limitation system is installed;
- .4 the ship speed (V_{ref});
- .5 the approximate ship speed ($V_{ref,app}$) for pre-EEDI ships in cases where the speed-power curve is not available, as specified in paragraph 2.2.3.5 of the EEXI Calculation Guidelines;
- .6 an approved speed-power curve under the EEDI condition as specified in paragraph 2.2 of the EEDI Calculation Guidelines, which is described in the EEDI Technical File, in cases where regulation 22 of MARPOL Annex VI (Attained EEDI) is applied;
- .7 an estimated speed-power curve under the EEDI condition, or under a different load draught to be calibrated to the EEDI condition, obtained from tank test and/or numerical calculations, if available;
- .8 estimation process and methodology of the power curves, as necessary, including documentation on consistency with the defined quality standards (e.g. ITTC 7.5-03-01-02 and ITTC 7.5-03-01-04 in their latest revisions) and the verification of the numerical set-up with parent hull or the reference set of comparable ships in case of using numerical calculations;
- .9 a sea trial report including sea trial results, which may have been calibrated by the tank test, under the sea condition as specified in paragraph 2.2.2 of the EEDI Calculation Guidelines, if available;
- .10 calculation process of $V_{ref,app}$ for pre-EEDI ships in cases where the speed-power curve is not available, as specified in paragraph 2.2.3.5 of the EEXI Calculation Guidelines;
- .11 type of fuel;

- .12 the specific fuel consumption (*SFC*) of the main and auxiliary engines, as specified in paragraph 2.2.3 of the EEXI Calculation Guidelines;
- .13 the electric power table² for certain ship types, as necessary, as defined in the EEDI Calculation Guidelines;
- .14 the documented record of annual average figure of the auxiliary engine load at sea obtained prior to the date of application for a survey for verification of the ship's EEXI, as specified in paragraph 2.2.2.3 of the EEXI Calculation Guidelines, if applicable;
- .15 calculation process of $P_{AE,app}$, as specified in paragraph 2.2.2.3 of the EEXI Calculation Guidelines, if applicable;
- .16 principal particulars, ship type and the relevant information to classify the ship as such a ship type, classification notations and an overview of the propulsion system and electricity supply system on board;
- .17 description of energy saving equipment, if available;
- .18 calculated value of the attained EEXI, including the calculation summary, which should contain, at a minimum, each value of the calculation parameters and the calculation process used to determine the attained EEXI; and
- .19 for LNG carriers:
 - .1 type and outline of propulsion systems (such as direct drive diesel, diesel electric, steam turbine);
 - .2 LNG cargo tank capacity in m³ and BOR as defined in paragraph 2.2.5.6.3 of the EEDI Calculation Guidelines;
 - .3 shaft power of the propeller shaft after transmission gear at 100% of the rated output of motor (MPP_{Motor}) and $\eta_{(i)}$ for diesel electric;
 - .4 shaft power of the propeller shaft after transmission gear at the de-rated output of motor ($MPP_{Motor,lim}$) in cases where the overridable Shaft / Engine Power Limitation is installed;
 - .5 maximum continuous rated power ($MCR_{SteamTurbine}$) for steam turbine;
 - .6 limited maximum continuous rated power ($MCR_{SteamTurbine,lim}$) for steam turbine in cases where the overridable Shaft / Engine Power Limitation is installed; and
 - .7 $SFC_{SteamTurbine}$ for steam turbine, as specified in paragraph 2.2.7.2 of the EEDI Calculation Guidelines. If the calculation is not available from the manufacturer, $SFC_{SteamTurbine}$ may be calculated by the submitter.

A sample of an EEXI Technical File is provided in the appendix.

² Electric power tables should be validated separately, taking into account the guidelines set out in appendix 2 of the 2014 *Guidelines on survey and certification of the Energy Efficiency Design Index (EEDI)* (resolution MEPC.254(67), as amended by resolutions MEPC.261(68) and MEPC.309(73)); consolidated text: MEPC.1/Circ.855/Rev.2, as may be further amended).

4.2.3 The *SFC* should be corrected to the value corresponding to the ISO standard reference conditions using the standard lower calorific value of the fuel oil, referring to ISO 15550:2002 and ISO 3046-1:2002. For the confirmation of the *SFC*, a copy of the approved NO_x Technical File and documented summary of the correction calculations should be submitted to the verifier.

4.2.4 For ships equipped with dual-fuel engine(s) using LNG and fuel oil, the *C_F*-factor for gas (LNG) and the specific fuel consumption (*SFC*) of gas fuel should be used by applying the criteria specified in paragraph 4.2.3 of the *2014 Guidelines on survey and certification of the Energy Efficiency Design Index (EEDI)*, as amended,³ as a basis for the guidance of the Administration.

4.2.5 Notwithstanding paragraphs 4.2.3 and 4.2.4, in cases where overridable Shaft / Engine Power Limitation is installed, or in cases where engines do not have a test report included in the NO_x Technical File, *SFC* should be calculated in accordance with paragraph 2.2.3 of the EEXI Calculation Guidelines. For this purpose, actual performance records of the engine may be used if satisfactory and acceptable to the verifier.

4.2.6 The verifier may request further information from the submitter, as specified in paragraph 4.2.7 of the EEDI Survey and Certification Guidelines, in addition to that contained in the EEXI Technical File, as necessary, to examine the calculation process of the attained EEXI.

4.2.7 In cases where the sea trial report as specified in paragraph 4.2.2.9 is submitted, the verifier should request further information from the submitter to confirm that:

- .1 the sea trial was conducted in accordance with the conditions specified in paragraphs 4.3.3, 4.3.4 and 4.3.7 of the EEDI Survey and Certification Guidelines, as applicable;
- .2 sea conditions were measured in accordance with ISO 15016:2002 or the equivalent if satisfactory and acceptable to the verifier;
- .3 ship speed was measured in accordance with ISO 15016:2002 or the equivalent if satisfactory and acceptable to the verifier; and
- .4 the measured ship speed was calibrated, if necessary, by taking into account the effects of wind, tide, waves, shallow water and displacement in accordance with ISO 15016:2002 or the equivalent which may be acceptable provided that the concept of the method is transparent for the verifier and publicly available/accessible.

4.2.8 The estimated speed-power curve obtained from the tank test and/or numerical calculations and/or the sea trial results calibrated by the tank test should be reviewed on the basis of the relevant documents in accordance with the EEDI Survey and Certification Guidelines, the defined quality standards (e.g. ITTC 7.5-03-01-02 and ITTC 7.5-03-01-04 in their latest revisions) and the verification of the numerical set-up with parent hull or the reference set of comparable ships.

4.2.9 In cases where the overridable Shaft / Engine Power Limitation system is installed, the verifier should confirm that the system is appropriately installed and sealed in accordance with the *2021 Guidelines on the Shaft / Engine Power Limitation system to comply with the EEXI requirements and use of a power reserve* (resolution MEPC.335(76)) and that a verified Onboard Management Manual (OMM) for overridable Shaft / Engine Power Limitation is on board the ship.

³ Resolution MEPC.254(67), as amended.

4.3 Verification of the attained EEXI in case of major conversion

4.3.1 In cases of a major conversion of a ship taking place at or after the completion date of the survey for EEXI verification specified in regulation 5.4.7 of MARPOL Annex VI, the shipowner should submit to a verifier an application for a general or partial survey with the EEXI Technical File duly revised, based on the conversion made and other relevant background documents.

4.3.2 The background documents should include as a minimum, but are not limited to:

- .1 details of the conversion;
- .2 EEXI parameters changed after the conversion and the technical justifications for each respective parameter;
- .3 reasons for other changes made in the EEXI Technical File, if any; and
- .4 calculated value of the attained EEXI with the calculation summary, which should contain, as a minimum, each value of the calculation parameters and the calculation process used to determine the attained EEXI after the conversion.

4.3.3 The verifier should review the revised EEXI Technical File and other documents submitted and verify the calculation process of the attained EEXI to ensure that it is technically sound and reasonable and follows regulation 23 of MARPOL Annex VI and the EEXI Calculation Guidelines.

4.3.4 For verification of the attained EEXI after the major conversion, speed trials of the ship may be conducted, as necessary.

APPENDIX

SAMPLE OF EEXI TECHNICAL FILE

1 Data

1.1 General information

Shipowner	XXX Shipping Line
Shipbuilder	XXX Shipbuilding Company
Hull no.	12345
IMO no.	94112XX
Ship type	Bulk carrier

1.2 Principal particulars

Length overall	250.0 m
Length between perpendiculars	240.0 m
Breadth, moulded	40.0 m
Depth, moulded	20.0 m
Summer load line draught, moulded	14.0 m
Deadweight at summer load line draught	150,000 tons

1.3 Main engine

Manufacturer	XXX Industries
Type	6J70A
Maximum continuous rating (MCR_{ME})	15,000 kW x 80 rpm
Limited maximum continuous rating with the Engine Power Limitation installed ($MCR_{ME,lim}$)	9,940 kW x 70 rpm
SFC at 75% of MCR_{ME} or 83% of $MCR_{ME,lim}$	166.5 g/kWh
Number of sets	1
Fuel type	Diesel Oil

1.4 Auxiliary engine

Manufacturer	XXX Industries
Type	5J-200
Maximum continuous rating (MCR_{AE})	600 kW x 900 rpm
SFC at 50% MCR_{AE}	220.0 g/kWh
Number of sets	3
Fuel type	Diesel Oil

1.5 Ship speed

Ship speed (V_{ref}) (with the Engine Power Limitation installed)	13.20 knots
---	-------------

2 Power curve

(Example 1; case of the EEDI ship)

An approved speed-power curve contained in the EEDI Technical File is shown in figure 2.1.

(Example 2; case of the pre-EEDI ship)

An estimated speed-power curve obtained from the tank test and/or numerical calculations, if available, is also shown in figure 2.1.

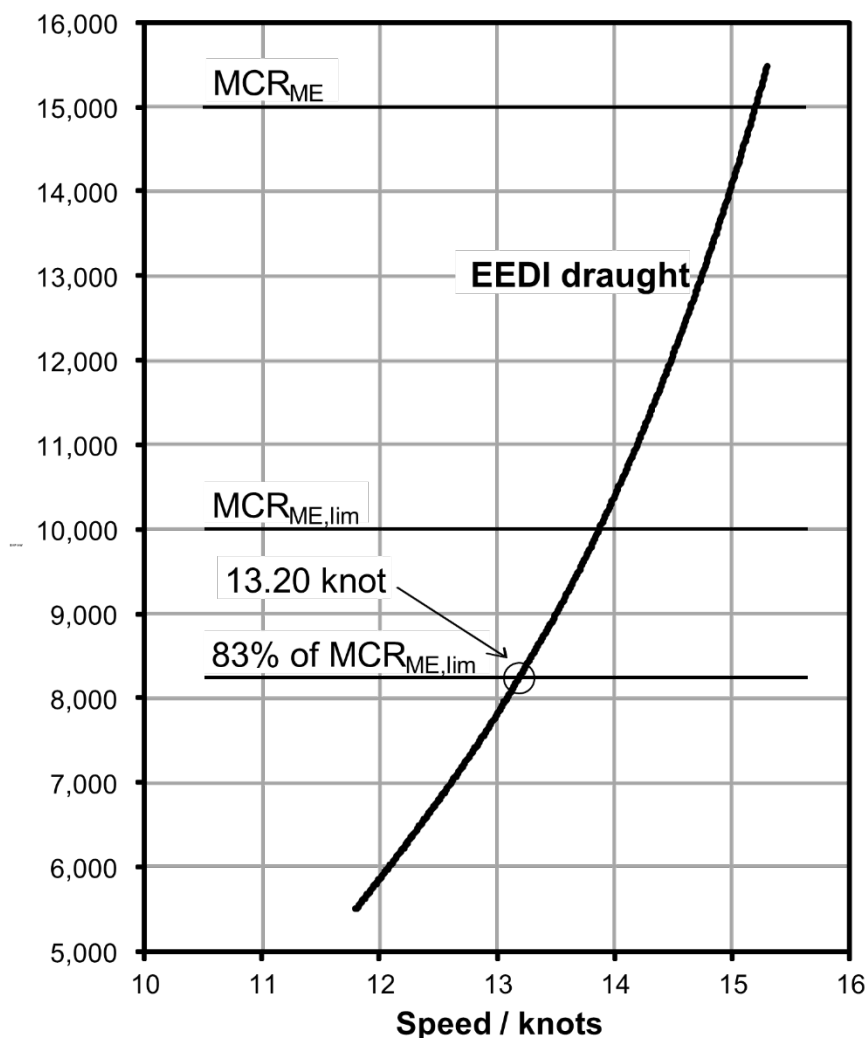

Figure 2.1: Power curve

(Example 3; case of the pre-EEDI ship with sea trial result calibrated to a different load draught)

An estimated speed-power curve under a ballast draught calibrated to the design load draught, obtained from the tank test and/or numerical calculations, if available, is shown in figure 2.2.

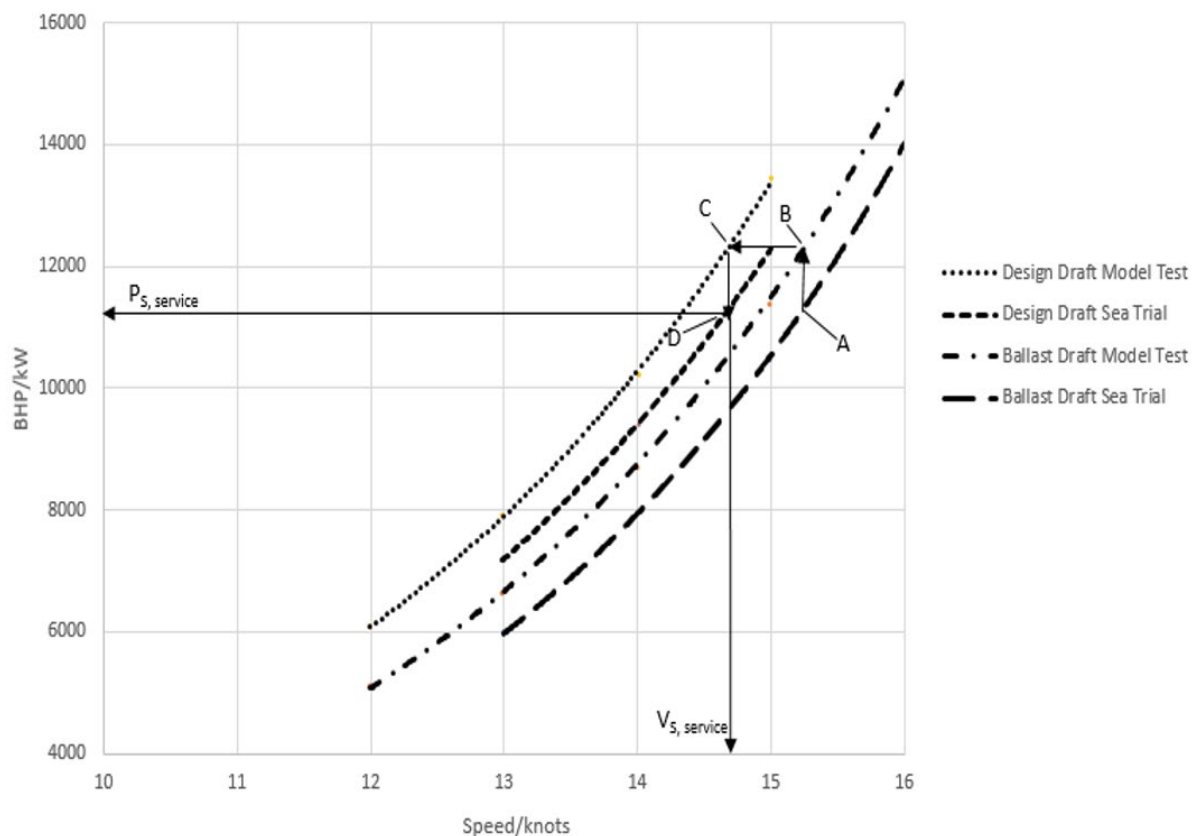

Figure 2.2: Power curve

3 Overview of propulsion system and electric power supply system

3.1 Propulsion system

3.1.1 Main engine

Refer to paragraph 1.3 of this appendix.

3.1.2 Propeller

Type	Fixed pitch propeller
Diameter	7.0 m
Number of blades	4
Number of sets	1

3.2 Electric power supply system

3.2.1 Auxiliary engines

Refer to paragraph 1.4 of this appendix.

3.2.2 Main generators

Manufacturer	XXX Electric
Rated output	560 kW (700 kVA) x 900 rpm
Voltage	AC 450 V
Number of sets	3

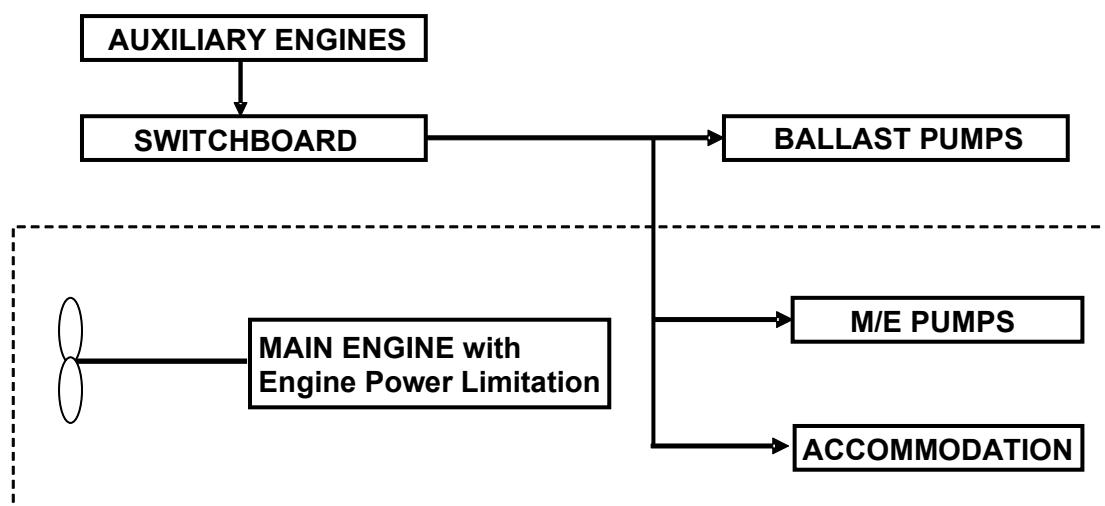

Figure 3.1: Schematic figure of propulsion and electric power supply system

4 Estimation process of speed-power curve

(Example; case of pre-EEDI ship)

Speed-power curve is estimated based on model test results and/or numerical calculations, if available. The flow of the estimation processes is shown below.

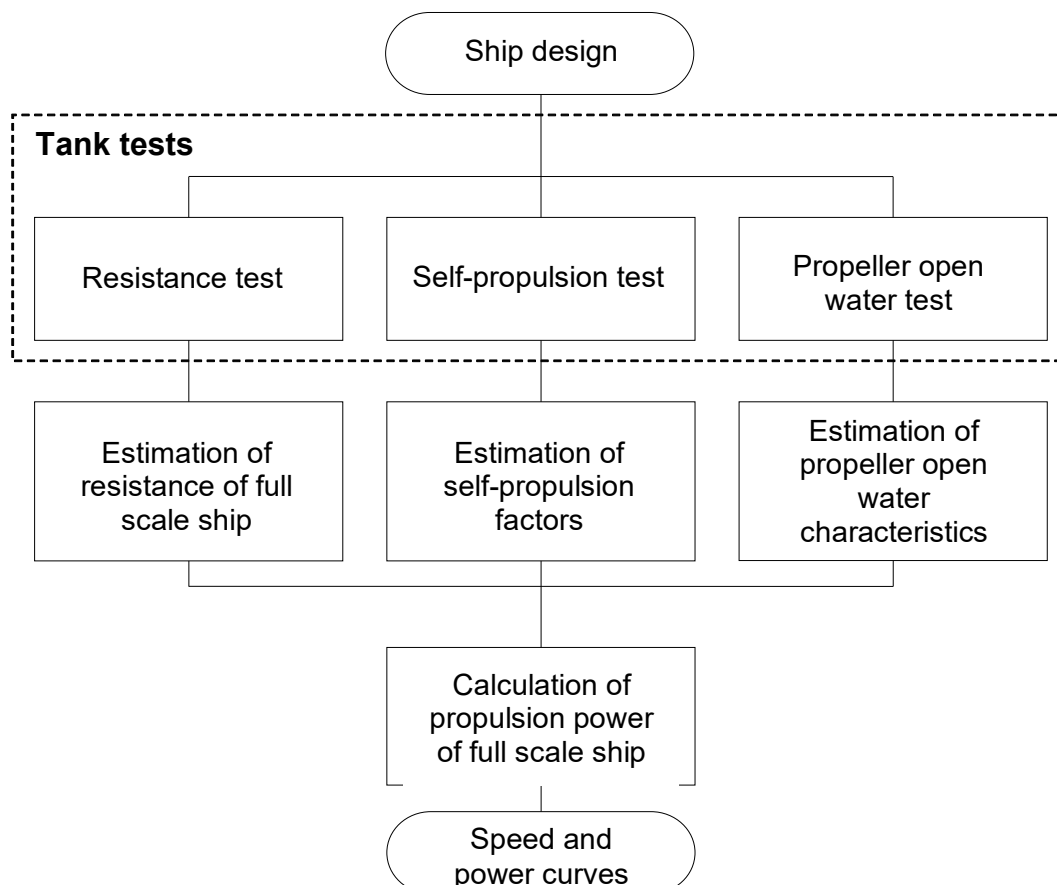

Figure 4: Flow chart of process for estimating speed-power curve from tank tests

5 Description of energy saving equipment

5.1 Energy saving equipment the effects of which are expressed as $P_{AEff(i)}$ and/or $P_{eff(i)}$ in the EEXI calculation formula

N/A

5.2 Other energy saving equipment

(Example)

5.2.1 Rudder fins

5.2.2 Rudder bulb

.....

(Specifications, schematic figures and/or photos, etc. for each piece of equipment or device should be indicated. Alternatively, attachment of a commercial catalogue may be acceptable.)

6 Calculated value of attained EEXI

6.1 Basic data

Type of ship	Capacity DWT	Speed V_{ref} (knots)
Bulk carrier	150,000	13.20

6.2 Main engine

MCR_{ME} (kW)	$MCR_{ME,lim}$ (kW)	P_{ME} (kW)	Type of fuel	C_{FME}	SFC_{ME} (g/kWh)
15,000	9,940	8,250	Diesel oil	3.206	166.5

6.3 Auxiliary engines

P_{AE} (kW)	Type of fuel	C_{FAE}	SFC_{AE} (g/kWh)
625	Diesel oil	3.206	220.0

6.4 Ice class

N/A

6.5 Innovative electrical energy-efficient technology

N/A

6.6 Innovative mechanical energy-efficient technology

N/A

6.7 Cubic capacity correction factor

N/A

6.8 Calculated value of attained EEXI

$$\begin{aligned}
 EEXI &= \frac{(\prod_{j=1}^M f_j)(\sum_{i=1}^{n_{ME}} P_{ME(i)} \cdot C_{FME(i)} \cdot SFC_{ME(i)}) + (P_{AE} \cdot C_{FAE} \cdot SFC_{AE})}{f_i \cdot f_c \cdot f_l \cdot Capacity \cdot f_w \cdot V_{ref} \cdot f_m} \\
 &+ \frac{\{(\prod_{j=1}^M f_j \cdot \sum_{i=1}^{n_{PTI}} P_{PTI(i)} - \sum_{i=1}^{n_{eff}} f_{eff(i)} \cdot P_{AE_{eff(i)}})\} \cdot C_{FAE} \cdot SFC_{AE}}{f_i \cdot f_c \cdot f_l \cdot Capacity \cdot f_w \cdot V_{ref} \cdot f_m} \\
 &- \frac{(\sum_{i=1}^{n_{eff}} f_{eff(i)} \cdot P_{eff(i)} \cdot C_{FME} \cdot SFC_{ME})}{f_i \cdot f_c \cdot f_l \cdot Capacity \cdot f_w \cdot V_{ref} \cdot f_m} \\
 &= \frac{1 \times (8250 \times 3.206 \times 166.5) + (625 \times 3.206 \times 220.0) + 0 - 0}{1 \times 1 \times 1 \times 150000 \times 1 \times 13.20 \times 1} \\
 &= 2.45 \text{ (g - CO}_2\text{/ton} \cdot \text{mile)}
 \end{aligned}$$

attained EEXI: 2.45 g-CO₂/ton mile

ANNEX 10

**RESOLUTION MEPC.336(76)
(adopted on 17 June 2021)**

**2021 GUIDELINES ON OPERATIONAL CARBON INTENSITY INDICATORS AND THE
CALCULATION METHODS (CII GUIDELINES, G1)**

THE MARINE ENVIRONMENT PROTECTION COMMITTEE,

RECALLING Article 38(a) of the Convention on the International Maritime Organization concerning the functions of the Marine Environment Protection Committee conferred upon it by international conventions for the prevention and control of marine pollution from ships,

NOTING that it adopted, by resolution MEPC.328(76), the 2021 revised MARPOL Annex VI, which is expected to enter into force on 1 November 2022 upon its deemed acceptance on 1 May 2022,

NOTING IN PARTICULAR that the 2021 revised MARPOL Annex VI contains amendments concerning mandatory goal-based technical and operational measures to reduce carbon intensity of international shipping,

NOTING FURTHER that regulation 28.1 of MARPOL Annex VI requires ships to which this regulation apply to calculate the attained annual operational CII taking into account the guidelines developed by the Organization,

RECOGNIZING that the aforementioned amendments to MARPOL Annex VI require relevant guidelines for uniform and effective implementation of the regulations and to provide sufficient lead time for industry to prepare,

HAVING CONSIDERED, at its seventy-sixth session, draft *2021 Guidelines on operational carbon intensity indicators and the calculation methods (CII Guidelines, G1)*,

1 ADOPTS the *2021 Guidelines on operational carbon intensity indicators and the calculation methods (CII Guidelines, G1)*, as set out in the annex to the present resolution;

2 INVITES Administrations to take the annexed Guidelines into account when developing and enacting national laws which give force to and implement requirements set forth in regulation 28.1 of MARPOL Annex VI;

3 REQUESTS the Parties to MARPOL Annex VI and other Member Governments to bring the annexed Guidelines to the attention of masters, seafarers, shipowners, ship operators and any other interested parties;

4 AGREES to consider substantiated proposals for CII correction factors for certain ship types, operational profiles and/or voyages with a view to enhancing, as appropriate, the annexed Guidelines before entry into force of the aforementioned amendments to MARPOL Annex VI;

5 AGREES to keep the Guidelines under review in light of experience gained with their implementation and in light of the review of CII regulations to be completed by the Organization by 1 January 2026 as identified in regulation 28.11 of MARPOL Annex VI.

ANNEX

2021 GUIDELINES ON OPERATIONAL CARBON INTENSITY INDICATORS AND THE CALCULATION METHODS (CII GUIDELINES, G1)

1 Introduction

1.1 In the *Initial IMO Strategy on Reduction of GHG Emissions from Ships* (Resolution MEPC.304(72)), the level of ambition on carbon intensity of international shipping is quantified by the CO₂ emissions per transport work, as an average across international shipping.

1.2 These Guidelines address the calculation methods and the applicability of the operational carbon intensity indicator (CII) for individual ships to which chapter 4 of MARPOL Annex VI, as amended, applies.

2 Definitions

2.1 *MARPOL* means the International Convention for the Prevention of Pollution from Ships, 1973, as modified by the Protocols of 1978 and 1997 relating thereto, as amended.

2.2 *IMO DCS* means the data collection system for fuel oil consumption of ships referred to in regulation 27 and related provisions of MARPOL Annex VI.

2.3 For the purpose of these Guidelines, the definitions in MARPOL Annex VI, as amended, apply.

2.4 The metrics indicating the average CO₂ emissions per transport work of a ship are generally referred to as operational carbon intensity indicator (CII) in these Guidelines.

.1 A specific CII calculated based on the actual or estimated mass or volume of the shipment carried on board a ship is generally referred to as *demand-based CII*; and

.2 A specific CII, in which calculation the capacity of a ship is taken as proxy of the actual mass or volume of the shipment carried on board, is generally referred to as *supply-based CII*.

2.5 The supply-based CII which uses DWT as the capacity is referred to as *AER*, and the supply-based CII which uses GT as the capacity is referred to as *cgDIST*.

3 Application

3.1 For all ships to which regulation 28 of MARPOL Annex VI applies, the operational carbon intensity indicators defined in section 4 should be applied.

3.2 The operational carbon intensity indicators defined in section 5 are encouraged to be additionally used by ships, where applicable, for trial purposes.

4 Operational carbon intensity indicator (CII) of individual ships for use in implementing regulation 28 of MARPOL Annex VI

In its most simple form, the attained annual operational CII of individual ships is calculated as the ratio of the total mass of CO₂ (M) emitted to the total transport work (W) undertaken in a given calendar year, as follows:

$$\text{attained } CII_{\text{ship}} = M / W \quad (1)$$

4.1 Mass of CO₂ emissions (M)

The total mass of CO₂ is the sum of CO₂ emissions (in grams) from all the fuel oil consumed on board a ship in a given calendar year, as follows:

$$M = FC_j \times C_{F_j} \quad (2)$$

where:

- J is the fuel oil type;
- FC_j is the total mass (in grams) of consumed fuel oil of type J in the calendar year, as reported under IMO DCS; and
- C_{F_j} represents the fuel oil mass to CO₂ mass conversion factor for fuel oil type J , in line with those specified in the *2018 Guidelines on the method of calculation of the attained Energy Efficiency Design Index (EEDI) for new ships (resolution MEPC.308(73))*, as may be further amended. In case the type of the fuel oil is not covered by the guidelines, the conversion factor should be obtained from the fuel oil supplier supported by documentary evidence.

4.2 Transport work (W)

In the absence of the data on actual transport work, the supply-based transport work (W_s) can be taken as a proxy, which is defined as the product of a ship's capacity and the distance travelled in a given calendar year, as follows:

$$W_s = C \times D_t \quad (3)$$

where:

- C represents the ship's capacity:
 - For bulk carriers, tankers, container ships, gas carriers, LNG carriers, ro-ro cargo ships, general cargo ships, refrigerated cargo carrier and combination carriers, deadweight tonnage (DWT)¹ should be used as Capacity;
 - For cruise passenger ships, ro-ro cargo ships (vehicle carriers) and ro-ro passenger ships, gross tonnage (GT)² should be used as Capacity; and
- D_t represents the total distance travelled (in nautical miles), as reported under IMO DCS.

¹ Deadweight tonnage (DWT) means the difference in tonnes between the displacement of a ship in water of relative density of 1,025 kg/m³ at the summer load draught and the lightweight of the ship. The summer load draught should be taken as the maximum summer draught as certified in the stability booklet approved by the Administration or any organization recognized by it.

² Gross tonnage (GT) should be calculated in accordance with the International Convention on Tonnage Measurement of Ships, 1969.

5 Operational carbon intensity indicator (CII) of individual ships for trial purpose

The following metrics are encouraged to be used for trial purposes, where applicable:

- .1 Energy Efficiency Performance Indicator (EEPI)

$$EEPI = \frac{M}{C \times D_l}$$

- .2 cbDIST

$$cbDIST = \frac{M}{ALB \times D_t}$$

- .3 clDIST

$$clDIST = \frac{M}{Lanemeter \times D_t}$$

- .4 EEOI, as defined in MEPC.1/Circ.684 on *Guidelines for voluntary use of the ship energy efficiency operational indicator (EEOI)*.

In the formulas above:

- the mass of CO₂ (M), the ship's capacity (C) and the total distance travelled (D_t) are identical with those used to calculate the attained CII of individual ships, as specified in section 4.1 and 4.2;
- D_l means the laden distance travelled (in nautical miles) when the ship is loaded;
- ALB means the number of available lower berths of a cruise passenger ship; and
- $Lanemeter$ means the length (in metres) of the lanes of a ro-ro ship.

ANNEX 11

**RESOLUTION MEPC.337(76)
(adopted on 17 June 2021)**

**2021 GUIDELINES ON THE REFERENCE LINES FOR USE WITH OPERATIONAL
CARBON INTENSITY INDICATORS (CII REFERENCE LINES GUIDELINES, G2)**

THE MARINE ENVIRONMENT PROTECTION COMMITTEE,

RECALLING Article 38(a) of the Convention on the International Maritime Organization concerning the functions of the Marine Environment Protection Committee conferred upon it by international conventions for the prevention and control of marine pollution from ships,

NOTING that it adopted, by resolution MEPC.328(76), the 2021 revised MARPOL Annex VI, which is expected to enter into force on 1 November 2022 upon its deemed acceptance on 1 May 2022,

NOTING IN PARTICULAR that the 2021 revised MARPOL Annex VI contains amendments concerning mandatory goal-based technical and operational measures to reduce carbon intensity of international shipping,

NOTING FURTHER that regulation 28.4 of MARPOL Annex VI requires reference lines to be established for each ship type to which regulation 28 is applicable,

HAVING CONSIDERED, at its seventy-sixth session, draft *2021 Guidelines on the reference lines for use with operational carbon intensity indicators (CII reference lines guidelines, G2)*,

1 ADOPTS the *2021 Guidelines on the reference lines for use with operational carbon intensity indicators (CII reference lines guidelines, G2)*, as set out in the annex to the present resolution;

2 INVITES Administrations to take the annexed Guidelines into account when developing and enacting national laws which give force to and implement requirements set forth in regulation 28.4 of MARPOL Annex VI;

3 REQUESTS the Parties to MARPOL Annex VI and other Member Governments to bring the annexed Guidelines to the attention of masters, seafarers, shipowners, ship operators and any other interested parties;

4 AGREES to keep the Guidelines under review in light of experience gained with their implementation and in light of the review of CII regulations to be completed by the Organization by 1 January 2026 as identified in regulation 28.11 of MARPOL Annex VI.

ANNEX

2021 GUIDELINES ON THE REFERENCE LINES FOR USE WITH OPERATIONAL CARBON INTENSITY INDICATORS (CII REFERENCE LINES GUIDELINES, G2)

1 Introduction

1.1 These Guidelines provide the methods to calculate the reference lines for use with operational carbon intensity indicators, and the ship type specific carbon intensity reference lines as referred to in regulation 28 of MARPOL Annex VI.

1.2 One reference line is developed for each ship type to which regulation 28 of MARPOL Annex VI applies, based on the specific indicators stipulated in *2021 Guidelines on operational carbon intensity indicators and the calculation methods* (G1) developed by the Organization, ensuring that only data from comparable ships are included in the calculation of each reference line.

2 Definition

2.1 *MARPOL* means the International Convention for the Prevention of Pollution from Ships, 1973, as modified by the Protocols of 1978 and 1997 relating thereto, as amended.

2.2 *IMO DCS* means the data collection system for fuel oil consumption of ships referred to in regulation 27 and related provisions of MARPOL Annex VI.

2.3 For the purpose of these Guidelines, the definitions in MARPOL Annex VI, as amended, apply.

2.4 An operational carbon intensity indicator (CII) reference line is defined as a curve representing the median attained operational carbon intensity performance, as a function of Capacity, of a defined group of ships in year of 2019.

3 Method to develop the CII reference lines

3.1 Given the limited data available for the year of 2008, the operational carbon intensity performance of ship types in year 2019 is taken as the reference.

3.2 For a defined group of ships, the reference line is formulated as follows:

$$CII_{ref} = aCapacity^{-c} \quad (1)$$

where CII_{ref} is the reference value of year 2019, $Capacity$ is identical with the one defined in the specific carbon intensity indicator (CII) for a ship type, as shown in Table. 1; a and c are parameters estimated through median regression fits, taking the attained CII and the Capacity of individual ships collected through IMO DCS in year 2019 as the sample.

4 Ship type specific operational carbon intensity reference lines

The parameters for determining the ship type specific reference lines, for use in Eq.(1), are specified as follows:

Table 1: Parameters for determining the 2019 ship type specific reference lines

Ship type		Capacity	<i>a</i>	<i>c</i>
Bulk carrier	279,000 DWT and above	279,000	4745	0.622
	less than 279,000 DWT	DWT	4745	0.622
Gas carrier	65,000 and above	DWT	14405E7	2.071
	less than 65,000 DWT	DWT	8104	0.639
Tanker		DWT	5247	0.610
Container ship		DWT	1984	0.489
General cargo ship	20,000 DWT and above	DWT	31948	0.792
	less than 20,000 DWT	DWT	588	0.3885
Refrigerated cargo carrier		DWT	4600	0.557
Combination carrier		DWT	40853	0.812
LNG carrier	100,000 DWT and above	DWT	9.827	0.000
	65,000 DWT and above, but less than 100,000 DWT	DWT	14479E10	2.673
	less than 65,000 DWT	65,000	14479E10	2.673
Ro-ro cargo ship (vehicle carrier)		GT	5739	0.631
Ro-ro cargo ship		DWT	10952	0.637
Ro-ro passenger ship		GT	7540	0.587
Cruise passenger ship		GT	930	0.383

ANNEX 12

**RESOLUTION MEPC.338(76)
(adopted on 17 June 2021)**

**2021 GUIDELINES ON THE OPERATIONAL CARBON INTENSITY REDUCTION
FACTORS RELATIVE TO REFERENCE LINES (CII REDUCTION
FACTORS GUIDELINES, G3)**

THE MARINE ENVIRONMENT PROTECTION COMMITTEE,

RECALLING Article 38(a) of the Convention on the International Maritime Organization concerning the functions of the Marine Environment Protection Committee conferred upon it by international conventions for the prevention and control of marine pollution from ships,

NOTING that it adopted, by resolution MEPC.328(76), the 2021 revised MARPOL Annex VI, which is expected to enter into force on 1 November 2022 upon its deemed acceptance on 1 May 2022,

NOTING IN PARTICULAR that the 2021 revised MARPOL Annex VI contains amendments concerning mandatory goal-based technical and operational measures to reduce carbon intensity of international shipping,

NOTING FURTHER that regulation 28.4 of MARPOL Annex VI requires reduction factors to be established for each ship type to which regulation 28 is applicable,

HAVING CONSIDERED, at its seventy-sixth session, draft *2021 Guidelines on the operational carbon intensity reduction factors relative to reference lines (CII reduction factors guidelines, G3)*,

1 ADOPTS the *2021 Guidelines on the operational carbon intensity reduction factors relative to reference lines (CII reduction factors guidelines, G3)*, as set out in the annex to the present resolution;

2 INVITES Administrations to take the annexed Guidelines into account when developing and enacting national laws which give force to and implement requirements set forth in regulation 28.4 of MARPOL Annex VI;

3 REQUESTS the Parties to MARPOL Annex VI and other Member Governments to bring the annexed Guidelines to the attention of masters, seafarers, shipowners, ship operators and any other interested parties;

4 AGREES to keep the Guidelines under review in light of experience gained with their implementation and in light of the review of CII regulations to be completed by the Organization by 1 January 2026 as identified in regulation 28.11 of MARPOL Annex VI, and that annual reduction rates for the period 2027-2030 will be further strengthened and developed taking into account that review.

ANNEX

2021 GUIDELINES ON THE OPERATIONAL CARBON INTENSITY REDUCTION FACTORS RELATIVE TO REFERENCE LINES (CII REDUCTION FACTORS GUIDELINES, G3)

1 Introduction

1.1 These Guidelines provide the methods to determine the annual operational carbon intensity reduction factors and their concrete values from year 2023 to 2030, as referred to in regulation 28 of MARPOL Annex VI.

1.2 The annual operational carbon intensity reduction factors apply to each ship type to which regulation 28 of MARPOL Annex VI applies, in a transparent and robust manner, based on the specific carbon intensity indicators stipulated in the *2021 Guidelines on operational carbon intensity indicators and the calculation methods (G1)* (resolution MEPC.336(76)) and the reference lines developed in the *2021 Guidelines on the reference lines for use with operational carbon intensity indicators (G2)*(resolution MEPC.337(76)).

1.3 The reduction factors have been set at the levels to ensure that, in combination with other relevant requirements of MARPOL Annex VI, the reduction in CO₂ emissions per transport work by at least 40% by 2030, compared to 2008, can be achieved as an average across international shipping.

1.4 Section 5 of these Guidelines provides background information on rational ranges of reduction factors of ship types in year 2030 using demand-based measurement and supply-based measurement.

1.5 The Organization should continue to monitor development in annual carbon intensity improvement using both demand-based measurement and supply-based measurement in parallel to the annual analysis of the fuel consumption data reported to the IMO DCS.

2 Definitions

2.1 *MARPOL* means the International Convention for the Prevention of Pollution from Ships, 1973, as modified by the Protocols of 1978 and 1997 relating thereto, as amended.

2.2 *IMO DCS* means the data collection system for fuel oil consumption of ships referred to in regulation 27 and related provisions of MARPOL Annex VI.

2.3 For the purpose of these Guidelines, the definitions in MARPOL Annex VI, as amended, apply.

2.4 The annual operational carbon intensity reduction factor, generally denoted as "Z" in regulation 28 of MARPOL Annex VI, is a positive value, stipulating the percentage points of the required annual operational carbon intensity indicator of a ship for a given year lower than the reference value.

3 Method to determine the annual reduction factor of ship types

3.1 Operational carbon intensity of international shipping

Given significant heterogeneity across ship types, the attained annual operational CII of international shipping as a whole is calculated as the ratio of the aggregated mass (in grams) of CO₂ (*aggregated M*) emitted to the aggregated mass (in tonne·nmiles) of transport work (*aggregated W*) undertaken by all individual ships of representative ship types in a given calendar year, as follows:

$$\text{attained } CII_{shipping} = \text{aggregated } M / \text{aggregated } W \quad (1)$$

In the absence of the data on actual annual transport work of individual ships, the aggregated transport work obtained from other reliable sources, such as UNCTAD, can be taken as approximation. The representative ship types refer to bulk carriers, gas carriers, tankers, container ships, general cargo ships, refrigerated cargo carrier and LNG carriers, as per the *Fourth IMO GHG Study 2020*.

3.2 The achieved carbon intensity reduction in international shipping

For a given year y , the achieved carbon intensity reduction in international shipping relative to the reference year y_{ref} , denoted as $R_{shipping,y}$, can be calculated as follows:

$$R_{shipping,y} = 100\% \times (\text{attained } CII_{shipping,y} - \text{attained } CII_{shipping,y_{ref}}) / \text{attained } CII_{shipping,y_{ref}} \quad (2)$$

where the $\text{attained } CII_{shipping,y}$ and $\text{attained } CII_{shipping,y_{ref}}$ represents the attained annual operational carbon intensity of international shipping in year y and in the reference year y_{ref} , as defined in Eq.(1).

The achieved carbon intensity reduction in international shipping can be alternatively calculated on the carbon intensity performance of ship types. Since CII metrics for different ship types may not be identical, the weighted average of the carbon intensity reduction achieved by ship types can be applied, as follows:

$$R_{shipping,y} = \sum_{type} f_{type,y} R_{type,y} \quad (3)$$

In Eq(3),

- $type$ represents the ship type;
- $f_{type,y}$ is the weight, which is equal to the proportion of CO₂ emitted by the ship type to the total CO₂ emissions of international shipping in year y ; and
- $R_{type,y}$ represents the carbon intensity reduction achieved by the ship type in year y , calculated as $R_{type,y} = 100\% \times (\text{attained } CII_{type,y} - \text{attained } CII_{type,y_{ref}}) / \text{attained } CII_{type,y_{ref}}$, where the $\text{attained } CII_{type,y}$ and $\text{attained } CII_{type,y_{ref}}$ represents the attained annual operational carbon intensity of the ship type in year y and in the reference year y_{ref} , as defined in Eq.(4), as follows:

$$\text{attained } CII_{type} = \sum_{ship} M_{ship,t} / \sum_{ship} W_{ship,t} \quad (4)$$

where:

$M_{ship,t}$ and $W_{ship,t}$ represents the total mass of CO₂ emitted from and the total transport work undertaken by a ship of this type in a given calendar year, as stipulated in the *Guidelines on operational carbon intensity indicators and the calculation methods (G1)*.

4 The reduction factors for the required annual operational CII of ship types

4.1 In accordance with regulation 28 of MARPOL Annex VI, the required annual operational CII for a ship is calculated as follows:

$$\text{Required annual operational CII} = (1 - Z / 100) \times CII_R$$

where CII_R is the reference value in year 2019 as defined in the *Guidelines on the reference lines for use with operational carbon intensity indicators (G2)*, Z is a general reference to the reduction factors for the required annual operational CII of ship types from year 2023 to 2030, as specified in table 1.

Table 1: Reduction factor (Z%) for the CII relative to the 2019 reference line

Year	Reduction factor relative to 2019
2023	5%*
2024	7%
2025	9%
2026	11%
2027	- **
2028	- **
2029	- **
2030	- **

Note:

- * Z factors of 1%, 2% and 3% are set for the years of 2020 to 2022, similar as business as usual until entry into force of the measure.
- ** Z factors for the years of 2027 to 2030 to be further strengthened and developed taking into account the review of the short-term measure.

5 Background information on rational ranges of reduction factors of ship types in year 2030

5.1 In the *Initial IMO Strategy on Reduction of GHG Emissions from Ships* (Resolution MEPC.304(72)), the levels of ambition on carbon intensity of international shipping have been set taking year 2008 as reference. The carbon intensity of international shipping in year 2008, as well as the improvement through 2012 to 2018, has been estimated in the *Fourth IMO GHG Study 2020*. However, since the scope and data collection methods applied in the *Fourth IMO GHG Study 2020* were inconsistent with those under IMO DCS, the results derived from the two sources cannot be compared directly.

5.2 To ensure the comparability of the attained carbon intensity of international shipping through year 2023 to 2030 with the reference line, the following methods are applied to calculate the equivalent carbon intensity target in year 2030 ($eR_{shipping,2030}$), taking year 2019 as reference, i.e. how much additional improvement is needed by 2030 from the 2019 performance level.

5.3 The achieved carbon intensity reduction of international shipping in year 2019 relative to year 2008 ($R_{shipping,2019}$) can be estimated as the sum of the achieved carbon intensity reduction of international shipping in year 2018 relative to year 2008 ($R_{shipping,2018}$) as given by the *Fourth IMO GHG Study 2020* and the estimated average annual improvement during 2012 and 2018 ($\bar{r}_{shipping}$), as follows:

$$R_{shipping,2019} = R_{shipping,2018} + \bar{r}_{shipping} \quad (5)$$

5.4 The following provides the calculations using demand-based measurement and supply-based measurement.

5.4.1 Demand-based measurement of 2030 target

As estimated by the *Fourth IMO GHG Study 2020*, the attained CII of international shipping (on aggregated demand-based metric) has reduced by **31.8%** ($R_{shipping,2018} = 31.8\%$) compared to 2008, with an estimated average annual improvement at **1.5** percentage points ($\bar{r}_{shipping} = 1.5\%$). In accordance with Eq.(5), the carbon intensity reduction achieved in year 2019 is estimated as **33.3%** ($R_{shipping,2019} = 33.3\%$).

5.4.2 Supply-based measurement of 2030 target

As estimated by the *Fourth IMO GHG Study 2020*, the attained CII of international shipping (on aggregated supply-based metric) has reduced by **22.0%** ($R_{shipping,2018} = 22.0\%$) compared to 2008, with an estimated average annual improvement at **1.6** percentage points ($\bar{r}_{shipping} = 1.6\%$). In accordance with Eq.(5), the carbon intensity reduction achieved in year 2019 relative to 2008 is estimated as **23.6%** ($R_{shipping,2019} = 23.6\%$).

5.5 Given the achieved carbon intensity reduction of international shipping in year 2019 relative to year 2008, the carbon intensity reduction target of international shipping in year 2030 can be converted to the equivalent target ($eR_{shipping,2030}$) relative to year 2019, as follows:

$$eR_{shipping,2030} = \frac{40\% - R_{shipping,2019}}{1 - R_{shipping,2019}} \quad (6)$$

5.5.1 Demand-based measurement of 2030 target

In accordance with Eq.(6), the equivalent reduction factor of international shipping in year 2030 relative to year 2019 ($eR_{shipping,2030}$) would be at least **10.0%** measured in aggregated demand-based CII metric, i.e. at least additional **10.0%** improvement from the 2019 level is needed by 2030.

5.5.2 Supply-based measurement of 2030 target

In accordance with Eq.(6), the equivalent reduction factor of international shipping in 2030 relative to year 2019 ($eR_{shipping,2030}$) would be at least **21.5%**, measured in aggregated supply-based CII metric, i.e. at least additional **21.5%** improvement from the 2019 level is needed by 2030.

ANNEX 13

**RESOLUTION MEPC.339(76)
(adopted on 17 June 2021)**

**2021 GUIDELINES ON THE OPERATIONAL CARBON INTENSITY
RATING OF SHIPS (CII RATING GUIDELINES, G4)**

THE MARINE ENVIRONMENT PROTECTION COMMITTEE,

RECALLING Article 38(a) of the Convention on the International Maritime Organization concerning the functions of the Marine Environment Protection Committee conferred upon it by international conventions for the prevention and control of marine pollution from ships,

NOTING that it adopted, by resolution MEPC.328(76), the 2021 revised MARPOL Annex VI, which is expected to enter into force on 1 November 2022 upon its deemed acceptance on 1 May 2022,

NOTING IN PARTICULAR that the 2021 revised MARPOL Annex VI contains amendments concerning mandatory goal-based technical and operational measures to reduce carbon intensity of international shipping,

NOTING FURTHER that regulation 28.6 of MARPOL Annex VI requires ships to which this regulation apply to determine operational carbon intensity rating taking into account guidelines developed by the Organization,

RECOGNIZING that the aforementioned amendments to MARPOL Annex VI require relevant guidelines for uniform and effective implementation of the regulations,

HAVING CONSIDERED, at its seventy-sixth session, draft *2021 Guidelines on the operational carbon intensity rating of ships (CII rating guidelines, G4)*,

1 ADOPTS the *2021 Guidelines on the operational carbon intensity rating of ships (CII rating guidelines, G4)*, as set out in the annex to the present resolution;

2 INVITES Administrations to take the annexed Guidelines into account when developing and enacting national laws which give force to and implement requirements set forth in regulation 28.6 of MARPOL Annex VI;

3 REQUESTS the Parties to MARPOL Annex VI and other Member Governments to bring the annexed Guidelines to the attention of masters, seafarers, shipowners, ship operators and any other interested parties;

4 AGREES to keep the Guidelines under review in light of experience gained with their implementation, of additional data collected and analysed, and in light of the review of CII regulations to be completed by the Organization by 1 January 2026 as identified in regulation 28.11 of MARPOL Annex VI.

ANNEX

2021 GUIDELINES ON THE OPERATIONAL CARBON INTENSITY RATING OF SHIPS (CII RATING GUIDELINES, G4)

1 Introduction

1.1 These Guidelines provide the methods to assign operational energy efficiency performance ratings to ships, as referred to in regulation 28 of MARPOL Annex VI. On this basis, the boundaries for determining a ship's annual operational carbon intensity performance from year 2023 to 2030 are also provided.

2 Definitions

2.1 *MARPOL* means the International Convention for the Prevention of Pollution from Ships, 1973, as modified by the Protocols of 1978 and 1997 relating thereto, as amended.

2.2 *IMO DCS* means the data collection system for fuel oil consumption of ships referred to in regulation 28 and related provisions of MARPOL Annex VI.

2.3 For the purpose of these Guidelines, the definitions in MARPOL Annex VI, as amended, apply.

2.4 *Operational carbon intensity rating* means to assign a ranking label from among the five grades (A, B, C, D and E) to the ship based on the attained annual operational carbon intensity indicator, indicating a major superior, minor superior, moderate, minor inferior, or inferior performance level.

3 Framework of the operational energy efficiency performance rating

3.1 An operational energy efficiency performance rating should be annually assigned to each ship to which regulation 28 of MARPOL Annex VI applies, in a transparent and robust manner, based on the deviation of the attained annual operational carbon intensity indicator (CII) of a ship from the required value.

3.2 To facilitate the rating assignment, for each year from 2023 to 2030, four boundaries are defined for the five-grade rating mechanism, namely superior boundary, lower boundary, upper boundary, and inferior boundary. Thus, a rating can be assigned through comparing the attained annual operational CII of a ship with the boundary values.

3.3 The boundaries are set based on the distribution of CIIs of individual ships in year 2019. The appropriate rating boundaries are expected to generate the following results: the middle 30% of individual ships across the fleet segment, in terms of the attained annual operational CIIs, are to be assigned rating C, while the upper 20% and further upper 15% of individuals are to be assigned rating D and E respectively, the lower 20% and further lower 15% of the individuals are to be assigned rating B and A respectively, as illustrated in figure 1.

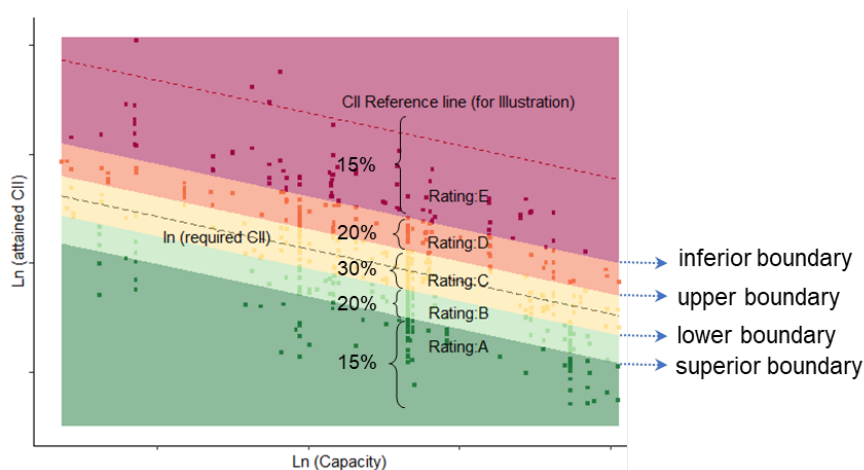

Figure 1: Operational energy efficiency performance rating scale

3.4 Given the incremental operational carbon intensity reduction factors over time, the boundaries for defining performance ratings should be synchronized accordingly, although the relative distance between the boundaries should not change. The rating of a ship would be determined by the attained CII and the predetermined rating boundaries, rather than the attained CII of other ships. Note that the distribution of ship individual ratings in a specific year may not be always identical with the scenario in 2019, where for example 20% may achieve A, 30% may achieve B, 40% may achieve C, 8% may achieve D and 2% may achieve E in a given year.

4 Method to determine the rating boundaries

4.1 The boundaries can be determined by the required annual operational CII in conjunction with the vectors, indicating the direction and distance they deviate from the required value (denoted as dd vectors for easy reference), as illustrated in figure 2.

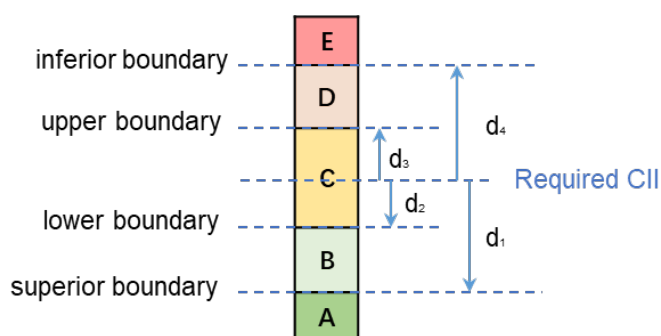

Figure 2: dd vectors and rating bands

4.2 Statistically, the dd vectors depend on the distribution of the attained annual operational CII of ships of the type concerned, which can be estimated through a quantile regression, taking data collected through DCS in year 2019 as the sample.

4.3 The quantile regression model for a specific ship type can be developed as follows:

$$\ln(\text{attained CII}) = \delta^{(p)} - c \ln(\text{Capacity}) + \varepsilon^{(p)}, \quad p = \{0.15, 0.35, 0.50, 0.65, 0.85\} \quad (5)$$

where $Capacity$ is identical with the one used in the operation carbon intensity indicator as specified in the Guidelines on operational carbon intensity indicators and the calculation

methods (G1); p is the typical quantile, meaning the proportion of observations with a lower value is $p\%$; $\delta^{(p)}$ is the constant term, and $\varepsilon^{(p)}$ is the error term.

4.4 The quantile regression lines in logarithm form are illustrated in Fig.3.

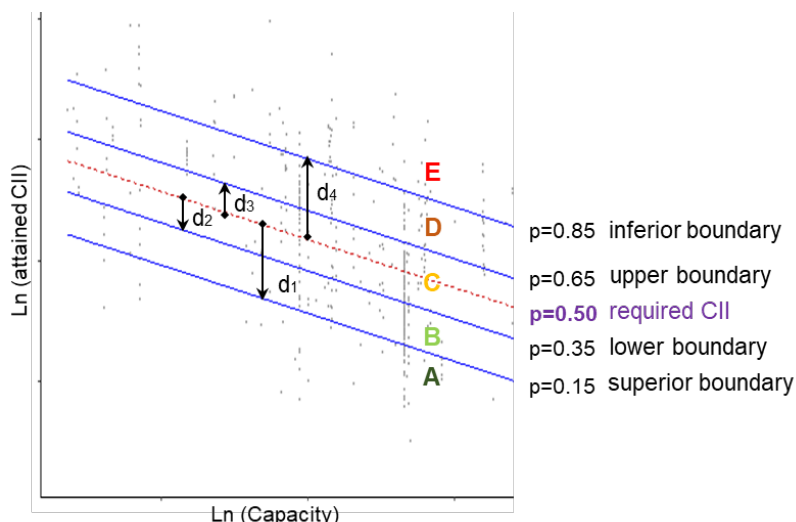

Figure 3: Quantile regression lines in logarithm form

4.5 Then, the dd vectors can be calculated based on the estimates of the intercept ($\hat{\delta}^{(p)}$), in accordance with Eq.(2), as follows:

$$\left. \begin{aligned} d_1 &= \hat{\delta}^{(0.15)} - \hat{\delta}^{(0.50)} \\ d_2 &= \hat{\delta}^{(0.35)} - \hat{\delta}^{(0.50)} \\ d_3 &= \hat{\delta}^{(0.65)} - \hat{\delta}^{(0.50)} \\ d_4 &= \hat{\delta}^{(0.85)} - \hat{\delta}^{(0.50)} \end{aligned} \right\} \quad (6)$$

4.6 Through an exponential transformation of each dd vector, the four boundaries fitted in the original data form can be derived based on the required annual operational carbon intensity indicator ($required\ CII$), as follows:

$$\left. \begin{aligned} \text{superior boundary} &= \exp(d_1) \cdot \text{required } CII \\ \text{lower boundary} &= \exp(d_2) \cdot \text{required } CII \\ \text{upper boundary} &= \exp(d_3) \cdot \text{required } CII \\ \text{inferior boundary} &= \exp(d_4) \cdot \text{required } CII \end{aligned} \right\} \quad (7)$$

Rating boundaries of ship types

The estimated dd vectors after exponential transformation for determining the rating boundaries of ship types are as follows:

Table 1: *dd* vectors for determining the rating boundaries of ship types

Ship type		Capacity in CII calculation	<i>dd</i> vectors (after exponential transformation)			
			exp(d1)	exp(d2)	exp(d3)	exp(d4)
Bulk carrier		DWT	0.86	0.94	1.06	1.18
Gas carrier	65,000 DWT and above	DWT	0.81	0.91	1.12	1.44
	less than 65,000 DWT	DWT	0.85	0.95	1.06	1.25
Tanker		DWT	0.82	0.93	1.08	1.28
Container ship		DWT	0.83	0.94	1.07	1.19
General cargo ship		DWT	0.83	0.94	1.06	1.19
Refrigerated cargo carrier		DWT	0.78	0.91	1.07	1.20
Combination carrier		DWT	0.87	0.96	1.06	1.14
LNG carrier	100,000 DWT and above	DWT	0.89	0.98	1.06	1.13
	less than 100,000 DWT		0.78	0.92	1.10	1.37
Ro-ro cargo ship (vehicle carrier)		GT	0.86	0.94	1.06	1.16
Ro-ro cargo ship		DWT	0.66	0.90	1.11	1.37
Ro-ro passenger ship		GT	0.72	0.90	1.12	1.41
Cruise passenger ship		GT	0.87	0.95	1.06	1.16

By comparing the attained annual operational CII of a specific ship with the four boundaries, a rating can then be assigned. For example, given the required CII of a bulk carrier in a specific year as 10 gCO₂/(dwt.nmile), then the superior boundary, lower boundary, upper boundary, and inferior boundary is 8.6, 9.4, 10.6 and 11.8 gCO₂/(dwt.nmile). If the attained CII is 9 gCO₂/(dwt.nmile), the ship would be rated as "B".
